

Watertight Devices
 30A, 3 Phase 250V AC, 3 Pole, 4 Wire
 Twist-Lock® Receptacle

HUBBELL

Features

- Impact resistant PBT lid, cover plate, and receptacle body
- Thermoplastic elastomer seal
- Stainless steel hardware and corrosion-resistant connection points



30A 3Ø 250V AC
 NEMA L15-30R
 UL/CSA
 3 HP



Ordering Information

Description	Device Color	UPC	Catalog Number
Thermoplastic elastomer yellow receptacle	Yellow	783585433288	HBL69W75

Listings

Listed to UL498
 Certified to CSA C22.2 No. 42
 Meets NEMA WD-1, WD-6 and ANSI standards
 UL Listed, CSA Certified to Type 4, 4X, 12, 6, 6P

Specifications

Body	PBT
Contact Carrier	White Nylon
Terminal Retainer	Clear polycarbonate
Contacts	Nickel plated brass
Core	White Nylon
Terminal Screws	Nickel plated brass
Hardware	Stainless Steel

Performance

Electrical

Current Interrupting	Rated for current interruption per UL498
Dielectric Voltage	2500V AC
Max Working Voltage	As marked
Temperature Rise	30°C max per UL498 at rated current

Environmental

Moisture Resistance	UL Listed 4, 4X, 12, 6, 6P
Operating temperatures	-40°C (without impact) to +60°C continuous
UV resistance	All exposed materials are UV stabilized

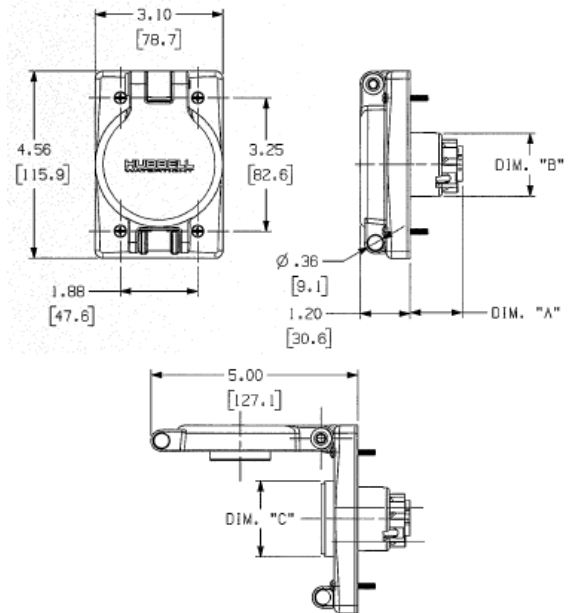

Complementary Products

Watertight Plug	HBL28W75
-----------------	----------

Online Resources

eCatalog

Dimensions in Inches (mm)

Hubbell Wiring Device-Kellems • Hubbell Incorporated (Delaware) • 40 Waterview Drive • Shelton, CT 06484

Phone (800) 288-6000 • Fax (800) 255-1031 • Specifications subject to change without notice.

