

Watertight Devices
Accessories
Weather Protective Lift Cover

HUBBELL

Features

- Impact resistant PBT cover plate
- Stainless steel hinge spring and pin
- Thermoplastic elastomer seal

Ordering Information

Description	Device Color	UPC	Catalog Number
Lift cover assembly; for use with locking 30A receptacles	Yellow	783585456515	HBL6800

Listings

Listed to UL514D / UL50E
Certified to CSA C22.2 No. 42
Meets NEMA WD-1, WD-6 and ANSI standards

Specifications

Flip Lid and Cover Plate	PBT
Sealing Collar	TPE
Mounting Plate	Stainless Steel
Spring and Hinge Pin	Stainless steel
Mounting Screws	Stainless Steel

Performance

Environmental	
Flammability	UL94 V-0
Moisture Resistance	UL Listed 3R, 3RX, 4X, 12
Operating temperatures	-40°C (without impact) to +60°C continuous
UV resistance	All exposed materials are UV stabilized

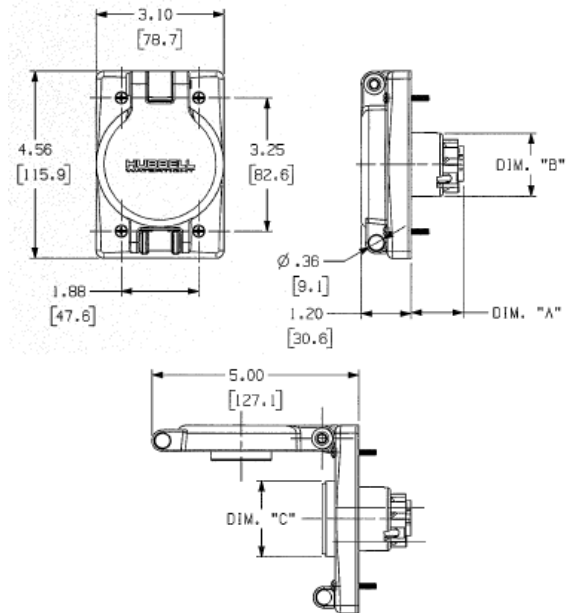

Online Resources

eCatalog

Dimensions in Inches (mm)

Hubbell Wiring Device-Kellems • Hubbell Incorporated (Delaware) • 40 Waterview Drive • Shelton, CT 06484

Phone (800) 288-6000 • Fax (800) 255-1031 • Specifications subject to change without notice.

