

Watertight Devices  
 20A, 3 Phase 480V AC, 3 Pole, 4 Wire  
 Twist-Lock® Receptacle

# HUBBELL

## Features

- Impact resistant PBT lid, cover plate, and receptacle body
- Thermoplastic elastomer seal
- Stainless steel hardware and corrosion-resistant connection points



## Ordering Information

Description	Device Color	UPC	Catalog Number
Thermoplastic elastomer yellow receptacle	Yellow	783585433196	HBL67W76

## Listings

Listed to UL498  
 Certified to CSA C22.2 No. 42  
 Meets NEMA WD-1, WD-6 and ANSI standards  
 UL Listed, CSA Certified to Type 4, 4X, 12, 6, 6P

## Specifications

Body	PBT
Contact Carrier	White Nylon
Terminal Retainer	Clear polycarbonate
Contacts	Nickel plated brass
Core	White Nylon
Terminal Screws	Nickel plated brass
Hardware	Stainless Steel

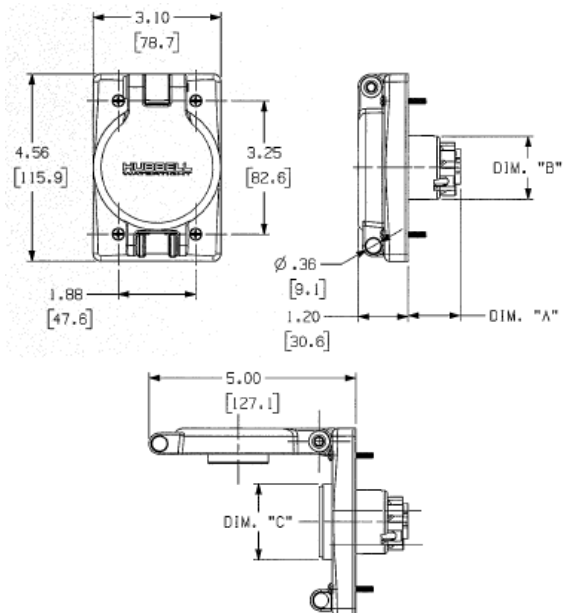

## Performance

### Electrical

Current Interrupting	Rated for current interruption per UL498
Dielectric Voltage	3500V AC
Max Working Voltage	As marked
Temperature Rise	30°C max per UL498 at rated current

### Environmental

Moisture Resistance	UL Listed 4, 4X, 12, 6, 6P
Operating temperatures	-40°C (without impact) to +60°C continuous
UV resistance	All exposed materials are UV stabilized

## Complementary Products

Watertight Plug	HBL26W76
-----------------	----------

## Online Resources

eCatalog

Dimensions in Inches (mm)

Hubbell Wiring Device-Kellems • Hubbell Incorporated (Delaware) • 40 Waterview Drive • Shelton, CT 06484

Phone (800) 288-6000 • Fax (800) 255-1031 • Specifications subject to change without notice.

