

Watertight Devices  
30A, 120/208V AC, 4 Pole, 5 Wire  
Twist-Lock® Plug

# HUBBELL

## Features

- Smooth body design minimizes collection points simplifying the wash down process
- Strain relief nut always seals on the body, minimizing debris collection
- Stainless steel hardware and corrosion-resistant connection points

## Ordering Information

Description	Cord Diameter	UPC	Catalog Number
Thermoplastic elastomer yellow plug	0.375"-1.000" (9.5-25.4)	783585131757	HBL28W81

## Listings

Listed to UL498  
Certified to CSA C22.2 No. 42  
Meets NEMA WD-1, WD-6 and ANSI standards  
UL Listed, CSA Certified to Type 4, 4X, 12, 6, 6P

## Specifications

Body	Thermoplastic Elastomer
Blade Holder	White Nylon
Terminal Retainer	Clear polycarbonate
Blades	Nickel plated brass
Core	White Nylon
Bushing & Cone Seal	Black Elastomer
Gotcha Ring	Nylon
Strain Relief Nut	PBT
Terminal Screws	Nickel Plated Brass

## Performance

### Electrical

Current Interrupting	Rated for current interruption per UL498
Dielectric Voltage	2500V AC
Max Working Voltage	As marked
Temperature Rise	30°C max per UL498 at rated current

### Mechanical

Cord Accomodation	0.375"-1.000" (9.5-25.4)
-------------------	--------------------------

### Environmental

Moisture Resistance	UL Listed 4, 4X, 12, 6, 6P
Operating temperatures	-40°C (without impact) to +60°C continuous
UV resistance	All exposed materials are UV stabilized

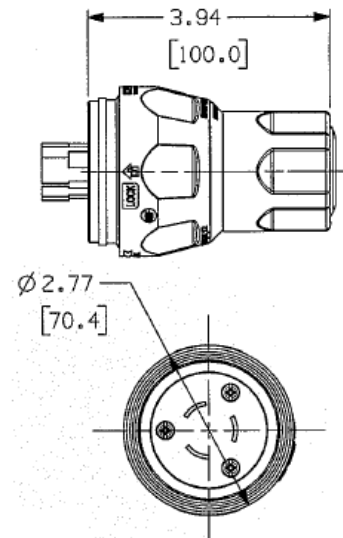

## Complementary Products

Watertight Connector	HBL29W81
Watertight Receptacle with Lift Cover	HBL69W81

## Online Resources

[eCatalog](#)

Dimensions in Inches (mm)

Hubbell Wiring Device-Kellems • Hubbell Incorporated (Delaware) • 40 Waterview Drive • Shelton, CT 06484

Phone (800) 288-6000 • Fax (800) 255-1031 • Specifications subject to change without notice.

