

REA™ 150 W Incandescent Luminaires ①

Enclosed and Gasketed

UNILETS® for use with Threaded Metal Conduit. Medium Base. Inexpensive, Low Wattage Fixture for use in Wet Locations.

Applications

- Vaportight enclosed and gasketed lighting fixtures, suitable for use in wet locations.
- Standard glass globes take up to 150 W A-21 lamps. Optional polycarbonate plastic globes take up to 100 W A-21 lamps.

Features

- Inexpensive fixture designed for use without reflector.
- Spring-mounted shock-absorbing socket prolongs lamp life.
- Guards snap on easily and securely. Spring-action balls snap into detents in fixture body.

Standard Materials

- Mounting bodies: pressure cast copperfree (4/10 of 1% max.) aluminum
- Socket: porcelain with brass screw shell
- Guards: steel or aluminum guards

Standard Finishes

- Mounting bodies: burnished
- Steel wire guard: zinc electroplate
- Aluminum guard: aluminum polymer enamel
- Socket and globes: natural finish

Certifications and Compliances

- UL Standard: UL 1598

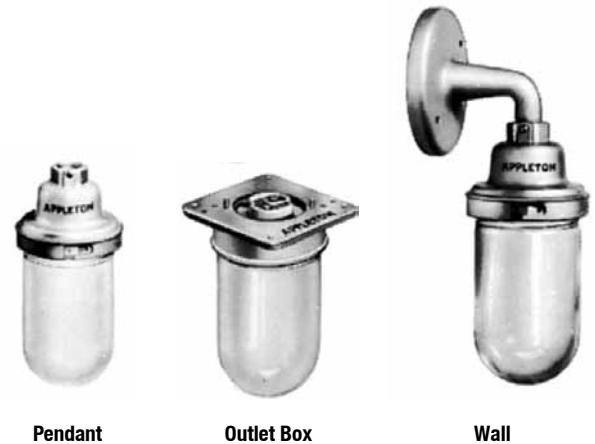

Pendant

Outlet Box

Wall

Dimensions in Inches/Millimeters

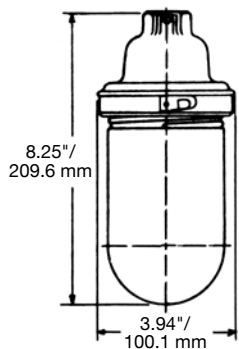

Pendant

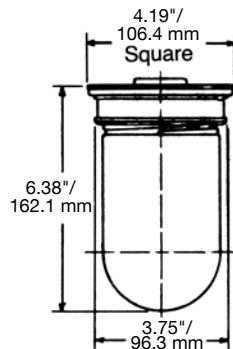

Outlet Box

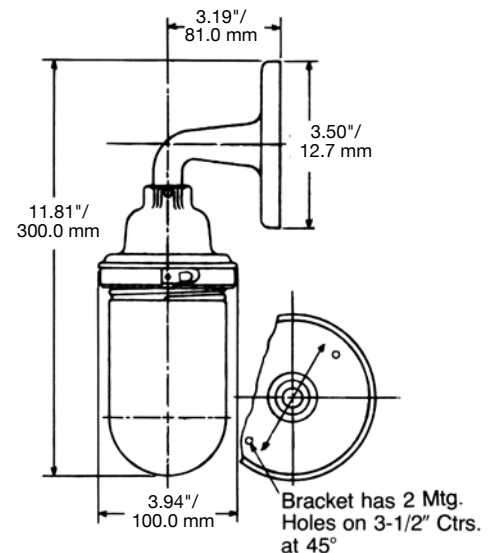





Wall



① Maximum size A-21 lamp: glass globe – 150 Watts; plastic globe – 100 Watts. No reflectors are available for REA fixtures.

REA™ 150 W Incandescent Luminaires ①

Enclosed and Gasketed

UNILETS® for use with Threaded Metal Conduit. Medium Base. Inexpensive, Low Wattage Fixture for use in Wet Locations.

		Description	Hub Size (Inches)	Catalog Number
 Pendant	 Outlet Box	Pendant Fixture	1/2	REA-1050
			3/4	REA-1075
		Outlet Box Fixture		REA-10B
		For 3-1/4" or 4" octagonal, or 4" square mounting.		
 Wall		Wall Fixture		REA-10LB
		Pendant Hood	1/2	REA-50
			3/4	REA-75
		Wall Bracket	1/2 male stem	REA-1BR
		Lamp Socket		VPLR-123
 VWG-1	 VGU-1	Steel Guard		VWG-1
		For Outlet Box fixture only.		
		Aluminum Guard		VGU-1
		For Pendant and Wall Mount fixtures only.		

		Description	Catalog Number ①	
			Glass	Plastic
		Colored Glass and Polycarbonate Globes		
 Glass	 Plastic	Clear	VGL-1CL	VPG-1CL
		Amber	VGL-1AM	VPG-1AM
		Blue	VGL-1BL	VPG-1BL
		Green	VGL-1GR	VPG-1GR
		Opal	VGL-1OP	—
		Red	VGL-1RE	VPG-1RE
		Clear Heat-Resistant	VGL-1HR	—

① Maximum size A-21 lamp: glass globe – 150 Watts; plastic globe – 100 Watts. No reflectors are available for REA fixtures.