



Magnetically latched lighting contactor
100 Amp
4NO / 0NC Poles
Maximum voltage rating 600VAC
Control voltage 110/120VAC 50/60Hz
Open device (no enclosure)

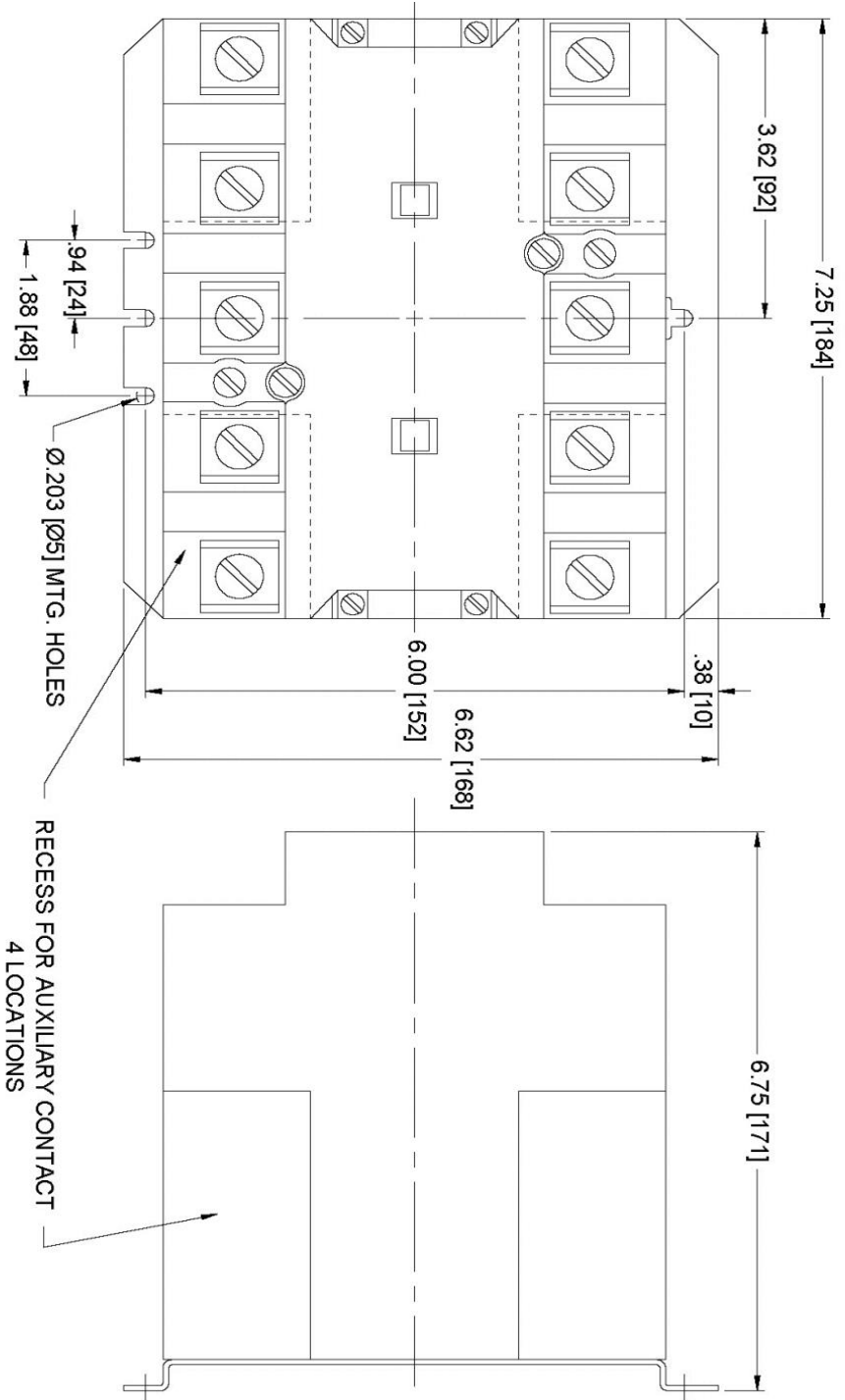

Image is representative and may not depict the actual product.

General technical data:	
Weight	8 lb
Height x Width x Depth	184 x 168 x 171 mm
Finger-safe (main circuit / control circuit)	No / No
Maximum altitude	6560 ft
Ambient storage temperature	(no data)
Ambient operating temperature	(no data)
Humidity (% non-condensing)	(no data)
Country of origin	USA
Contactors:	
Number of poles	4NO / 0NC
Mechanical operating cycles	5,000,000
Current ratings:	
Tungsten (poles per phase)	100A @277V 1p 1ph 100A @480V 2p 1ph 100A @480V 3p 3ph
Ballast (poles per phase)	100A @347V 1p 1ph 100A @600V 2p 1ph 100A @600V 3p 3ph
General & resistive (poles per phase)	100A @347V 1p 1ph 100A @600V 2p 1ph 100A @600V 3p 3ph
Internal/standard auxiliary contact:	
Number of NC / NO auxiliary contacts	0NC / 0NO
Rating	NA
Optional auxiliary contact:	
Max number of NC / NO auxiliary contacts	4 max NC/NO combination
Rating	10A@600VAC (A600), 1A@300VDC (R300)
Coil:	
Voltage	110/120V 50/60Hz Coil
Sealed watts	(no data)
Inrush / sealed power	1300 / 130 VA
Normal coil operating limits (% of rated voltage)	85% - 110%
Typical drop-out volts (% of rated voltage)	(no data)
Pick-up time / Drop-out time	(no data)
Disconnect type (none):	
Rating	NA
Fuse type accepted	NA

Enclosure:	
Type	Open device (no enclosure)
Rating	NA
Mounting/wiring:	
Mounting orientation	Vertical
Mounting type	Surface
Line side connection type / torque	Box lug / 90 - 100 lb-in.
Line side solid & stranded conductors	6 - 1/0 AWG 75°C AL or CU
Load side connection type / torque	Box lug / 90 - 100 lb-in.
Load side solid & stranded conductors	6 - 1/0 AWG 75°C AL or CU
Coil connection type / torque	Screw / 8 - 12 lb in.
Coil solid & stranded conductors	2 x (16 - 12 AWG) CU 75°C
Main auxiliary contact connection type / torque	NA
Main auxiliary contact solid & stranded conductors	NA
Short circuit current rating:	
Fuses	none
Thermal magnetic circuit breaker	5kA@600V (100A max CB)
Additional information:	
	Brochure

CLM, 100/200A, 4-5 POLE



Dimensions in inches [mm]

Ref. D38324

Wiring Diagram Class CLM 30-200 Amp 2, 3, 4 and 5 Pole

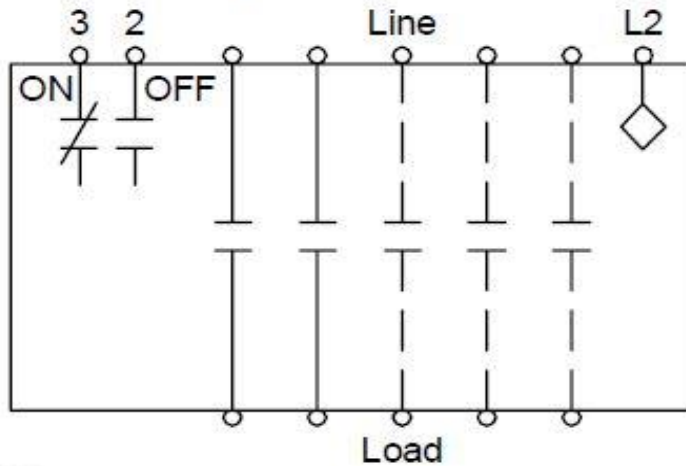

Notes:

1. Dotted lines represent additional poles. Contactor may have 2, 3, 4 or 5 poles.
2. Optional auxiliary contacts are not shown.