



CIRCUIT-BREAKER SZ S00, FOR MOTOR PROTECTION, CLASS 10, W. OVERLOAD RELAY FUNCTION A-RELEASE 3.5...5A, N-RELEASE 65A, SCREW CONNECTION, STANDARD SW. CAPACITY

product brand name	SIRIUS
Product designation	3RV2 circuit breaker

General technical data:

Size of contactor can be combined company-specific	S0
Product expansion	Yes
• Auxiliary switch	Yes
Active power loss total typical	6 W
Insulation voltage	690 V
• with degree of pollution 3 Rated value	690 V
Surge voltage resistance Rated value	6 kV
Protection class IP	IP20
• on the front	IP20
• of the terminal	IP20
Mechanical service life (switching cycles)	100 000
• of the main contacts typical	100 000
• of the auxiliary contacts typical	100 000
Electrical endurance (switching cycles)	100 000
• typical	100 000
Temperature compensation	-20 ... +60 °C
Type of protection	Increased safety

Ambient conditions:

Installation altitude at height above sea level maximum	2 000 m
Ambient temperature	-20 ... +60 °C
• during operation	-20 ... +60 °C

<ul style="list-style-type: none"> during storage 	-50 ... +80 °C
<ul style="list-style-type: none"> during transport 	-50 ... +80 °C
Relative humidity during operation	10 ... 95 %

Main circuit:

Adjustable response value current of the current-dependent overload release	3.5 ... 5 A
Operating voltage	
<ul style="list-style-type: none"> Rated value 	690 V
<ul style="list-style-type: none"> at AC-3 Rated value maximum 	690 V
Operating frequency Rated value	50 ... 60 Hz
Operating current Rated value	5 A
Operating current	
<ul style="list-style-type: none"> at AC-3 	
<ul style="list-style-type: none"> — at 400 V Rated value 	5 A
Operating power	
<ul style="list-style-type: none"> at AC-3 	
<ul style="list-style-type: none"> — at 230 V Rated value 	1 100 W
<ul style="list-style-type: none"> — at 400 V Rated value 	2 200 W
<ul style="list-style-type: none"> — at 500 V Rated value 	2 200 W
<ul style="list-style-type: none"> — at 690 V Rated value 	4 000 W
Operating frequency	
<ul style="list-style-type: none"> at AC-3 maximum 	15 1/h

Auxiliary circuit:

Number of NC contacts	
<ul style="list-style-type: none"> for auxiliary contacts 	0
Number of NO contacts	
<ul style="list-style-type: none"> for auxiliary contacts 	0
Number of CO contacts	
<ul style="list-style-type: none"> for auxiliary contacts 	0
Design of the auxiliary switch	laterally
Operating current of the auxiliary contacts at AC-15	
<ul style="list-style-type: none"> at 24 V 	1.5 A
<ul style="list-style-type: none"> at 230 V 	1.5 A
Operating current of the auxiliary contacts at DC-13	
<ul style="list-style-type: none"> at 24 V 	1 A

Protective and monitoring functions:

Trip class	CLASS 10
Design of the overload circuit breaker	thermal
Operational short-circuit current breaking capacity (Ics) at AC	
<ul style="list-style-type: none"> at 240 V Rated value 	100 kA

<ul style="list-style-type: none"> • at 400 V Rated value • at 500 V Rated value • at 690 V Rated value 	<p>100 kA</p> <p>100 kA</p> <p>4 kA</p>
Maximum short-circuit current breaking capacity (Icu) <ul style="list-style-type: none"> • at AC at 240 V Rated value • with AC at 400 V Rated value • at AC at 500 V Rated value • at AC at 690 V Rated value 	<p>100 kA</p> <p>100 kA</p> <p>100 kA</p> <p>6 kA</p>
Breaking capacity short-circuit current (Icn) <ul style="list-style-type: none"> • with 1 current path at DC at 150 V Rated value • with 2 current paths in series at DC at 300 V Rated value • with 3 current paths in series at DC at 450 V Rated value 	<p>10 kA</p> <p>10 kA</p> <p>10 kA</p>
Response value current of the instantaneous short-circuit release	<p>65 A</p>

UL/CSA ratings:

Full-load current (FLA) for three-phase AC motor <ul style="list-style-type: none"> • at 480 V Rated value • at 600 V Rated value 	<p>5 A</p> <p>5 A</p>
yielded mechanical performance [hp] <ul style="list-style-type: none"> • for single-phase AC motor <ul style="list-style-type: none"> — at 110/120 V Rated value — at 230 V Rated value • for three-phase AC motor <ul style="list-style-type: none"> — at 200/208 V Rated value — at 220/230 V Rated value — at 460/480 V Rated value — at 575/600 V Rated value 	<p>0.167 hp</p> <p>0.5 hp</p> <p>1 hp</p> <p>1 hp</p> <p>3 hp</p> <p>3 hp</p>
Contact rating of the auxiliary contacts acc. to UL	<p>C600 / R300</p>

Short-circuit:

Design of the short-circuit trip	<p>magnetic</p>
Design of the fuse link <ul style="list-style-type: none"> • for short-circuit protection of the auxiliary switch required 	<p>fuse gL/gG: 6 A, quick: 10 A</p>
Design of the fuse link for IT network for short-circuit protection of the main circuit <ul style="list-style-type: none"> • at 400 V • at 500 V • at 690 V 	<p>gL/gG 32 A</p> <p>gL/gG 32 A</p> <p>gL/gG 25 A</p>

Installation/ mounting/ dimensions:

mounting position	any
Mounting type	screw and snap-on mounting onto 35 mm standard mounting rail according to DIN EN 60715
Height	97 mm
Width	65 mm
Depth	96 mm
Required spacing	
<ul style="list-style-type: none"> • with side-by-side mounting <ul style="list-style-type: none"> — forwards 0 mm — Backwards 0 mm — upwards 50 mm — downwards 50 mm — at the side 0 mm • for grounded parts <ul style="list-style-type: none"> — forwards 0 mm — Backwards 0 mm — upwards 50 mm — at the side 30 mm — downwards 50 mm • for live parts <ul style="list-style-type: none"> — forwards 0 mm — Backwards 0 mm — upwards 50 mm — downwards 50 mm — at the side 30 mm 	

Connections/ Terminals:	
Product function	
<ul style="list-style-type: none"> • removable terminal for auxiliary and control circuit 	No
Type of electrical connection	
<ul style="list-style-type: none"> • for main current circuit • for auxiliary and control current circuit 	screw-type terminals screw-type terminals
Arrangement of electrical connectors for main current circuit	Top and bottom
Type of connectable conductor cross-section	
<ul style="list-style-type: none"> • for main contacts <ul style="list-style-type: none"> — single or multi-stranded 2x (0,75 ... 2,5 mm²), 2x 4 mm² — finely stranded with core end processing 2x (0.5 ... 1.5 mm²), 2x (0.75 ... 2.5 mm²) • for AWG conductors for main contacts 2x (18 ... 14), 2x 12 	
Type of connectable conductor cross-section	
<ul style="list-style-type: none"> • for auxiliary contacts <ul style="list-style-type: none"> — single or multi-stranded 2x (0,5 ... 1,5 mm²), 2x (0,75 ... 2,5 mm²) 	



— finely stranded with core end processing	2x (0.5 ... 1.5 mm ²), 2x (0.75 ... 2.5 mm ²)
• for AWG conductors for auxiliary contacts	2x (20 ... 16), 2x (18 ... 14)
Design of screwdriver shaft	Diameter 5 to 6 mm
Design of the thread of the connection screw	
• for main contacts	M3
• of the auxiliary and control contacts	M3

Safety related data:	
B10 value with high demand rate acc. to SN 31920	50 000
Proportion of dangerous failures	
• with low demand rate acc. to SN 31920	40 %
• with high demand rate acc. to SN 31920	40 %
T1 value for proof test interval or service life acc. to IEC 61508	10 y





Mechanical data:	
Size of the circuit-breaker	S00

Display:	
Display version	
• for switching status	Handle



Certificates/ approvals:

General Product Approval	Declaration of Conformity	Test Certificates
 CSA	 EG-Konf.	Typprüfbescheinigung/Werkszeugnis spezielle Prüfbescheinigungen

Shipping Approval

 ABS	 BUREAU VERITAS	 DNV	 GL	 LRS	 PRS
--	---	--	---	--	--

Shipping Approval

Shipping Approval	other
 RINA	 RMRS

[Umweltbestätigung](#)

[Bestätigungen](#)



VDE

Further information

Information- and Downloadcenter (Catalogs, Brochures,...)
<http://www.siemens.com/industrial-controls/catalogs>

Industry Mall (Online ordering system)

<http://www.siemens.com/industrymall>

Cax online generator

<http://support.automation.siemens.com/WW/CAXorder/default.aspx?lang=en&mfb=3RV2111FA10>

Service&Support (Manuals, Certificates, Characteristics, FAQs,...)

<https://support.industry.siemens.com/cs/ww/en/ps/3RV2111FA10>

Image database (product images, 2D dimension drawings, 3D models, device circuit diagrams, EPLAN macros, ...)

http://www.automation.siemens.com/bilddb/cax_de.aspx?mfb=3RV2111FA10&lang=en

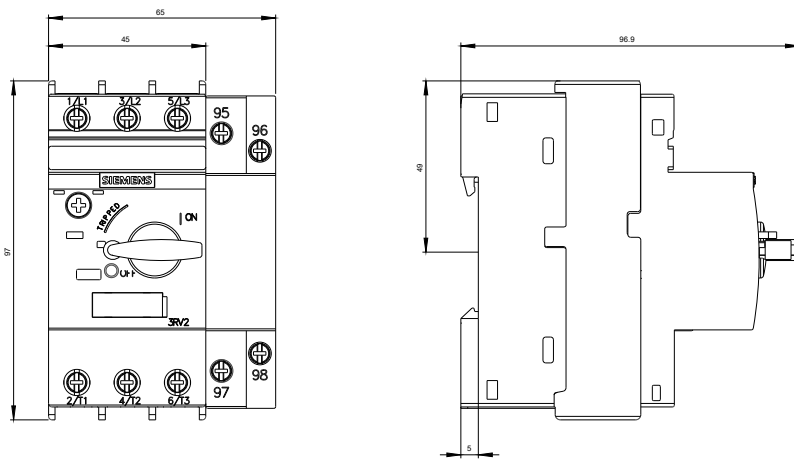

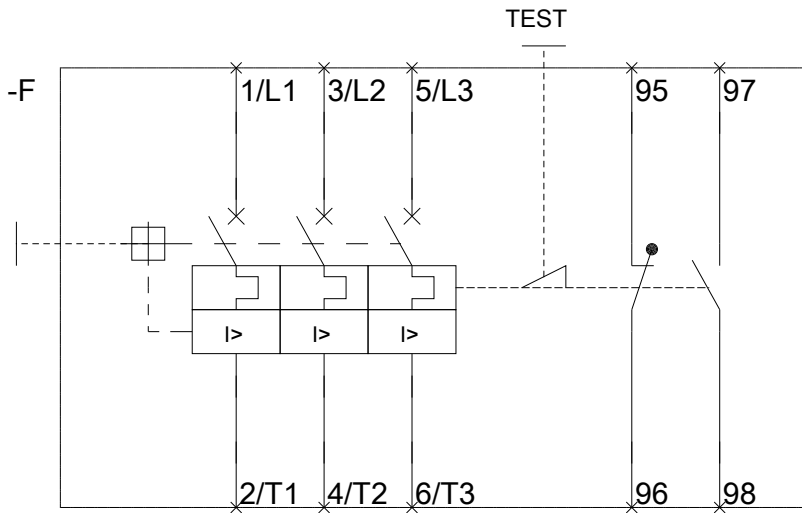
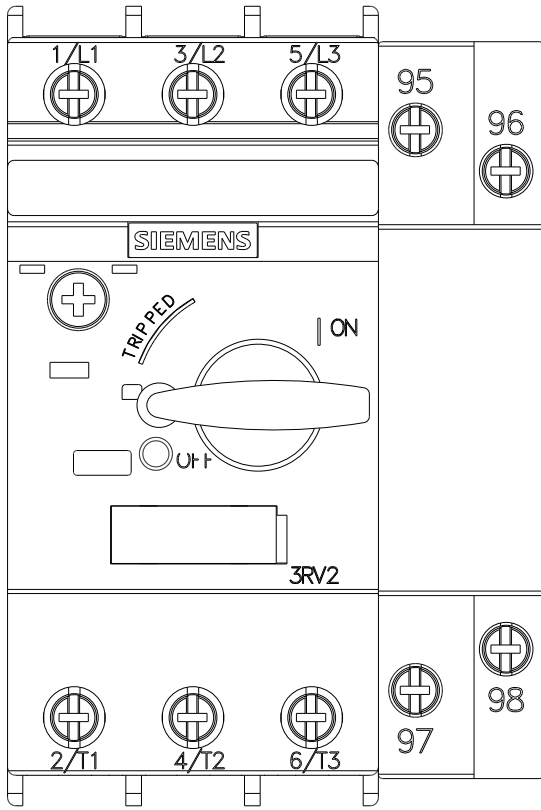

last modified:

29.06.2015