



CIRCUIT-BREAKER SZ S00, FOR MOTOR PROTECTION, CLASS 10, W. OVERLOAD RELAY FUNCTION A-RELEASE 2.2...3.2A, N-RELEASE42A, SCREW CONNECTION, STANDARD SW. CAPACITY

product brand name	SIRIUS
Product designation	3RV2 circuit breaker

**General technical data:**

Size of contactor can be combined company-specific	S0
Product expansion	Yes
• Auxiliary switch	Yes
Active power loss total typical	6 W
Insulation voltage	690 V
• with degree of pollution 3 Rated value	690 V
Surge voltage resistance Rated value	6 kV
Protection class IP	IP20
• on the front	IP20
• of the terminal	IP20
Mechanical service life (switching cycles)	100 000
• of the main contacts typical	100 000
• of the auxiliary contacts typical	100 000
Electrical endurance (switching cycles)	100 000
• typical	100 000
Temperature compensation	-20 ... +60 °C
Type of protection	Increased safety

**Ambient conditions:**

Installation altitude at height above sea level maximum	2 000 m
Ambient temperature	-20 ... +60 °C
• during operation	-20 ... +60 °C

<ul style="list-style-type: none"> <li>during storage</li> </ul>	-50 ... +80 °C
<ul style="list-style-type: none"> <li>during transport</li> </ul>	-50 ... +80 °C
<b>Relative humidity during operation</b>	10 ... 95 %

#### Main circuit:

<b>Adjustable response value current of the current-dependent overload release</b>	2.2 ... 3.2 A
<b>Operating voltage</b>	
<ul style="list-style-type: none"> <li>Rated value</li> </ul>	690 V
<ul style="list-style-type: none"> <li>at AC-3 Rated value maximum</li> </ul>	690 V
<b>Operating frequency Rated value</b>	50 ... 60 Hz
<b>Operating current Rated value</b>	3.2 A
<b>Operating current</b>	
<ul style="list-style-type: none"> <li>at AC-3</li> </ul>	
<ul style="list-style-type: none"> <li>— at 400 V Rated value</li> </ul>	3.2 A
<b>Operating power</b>	
<ul style="list-style-type: none"> <li>at AC-3</li> </ul>	
<ul style="list-style-type: none"> <li>— at 230 V Rated value</li> </ul>	550 W
<ul style="list-style-type: none"> <li>— at 400 V Rated value</li> </ul>	1 100 W
<ul style="list-style-type: none"> <li>— at 500 V Rated value</li> </ul>	1 500 W
<ul style="list-style-type: none"> <li>— at 690 V Rated value</li> </ul>	2 200 W
<b>Operating frequency</b>	
<ul style="list-style-type: none"> <li>at AC-3 maximum</li> </ul>	15 1/h

#### Auxiliary circuit:

<b>Number of NC contacts</b>	
<ul style="list-style-type: none"> <li>for auxiliary contacts</li> </ul>	0
<b>Number of NO contacts</b>	
<ul style="list-style-type: none"> <li>for auxiliary contacts</li> </ul>	0
<b>Number of CO contacts</b>	
<ul style="list-style-type: none"> <li>for auxiliary contacts</li> </ul>	0
<b>Design of the auxiliary switch</b>	laterally
<b>Operating current of the auxiliary contacts at AC-15</b>	
<ul style="list-style-type: none"> <li>at 24 V</li> </ul>	1.5 A
<ul style="list-style-type: none"> <li>at 230 V</li> </ul>	1.5 A
<b>Operating current of the auxiliary contacts at DC-13</b>	
<ul style="list-style-type: none"> <li>at 24 V</li> </ul>	1 A

#### Protective and monitoring functions:

<b>Trip class</b>	CLASS 10
<b>Design of the overload circuit breaker</b>	thermal
<b>Operational short-circuit current breaking capacity (Ics) at AC</b>	
<ul style="list-style-type: none"> <li>at 240 V Rated value</li> </ul>	100 kA

<ul style="list-style-type: none"> <li>• at 400 V Rated value</li> <li>• at 500 V Rated value</li> <li>• at 690 V Rated value</li> </ul>	<p>100 kA</p> <p>100 kA</p> <p>10 kA</p>
<b>Maximum short-circuit current breaking capacity (Icu)</b> <ul style="list-style-type: none"> <li>• at AC at 240 V Rated value</li> <li>• with AC at 400 V Rated value</li> <li>• at AC at 500 V Rated value</li> <li>• at AC at 690 V Rated value</li> </ul>	<p>100 kA</p> <p>100 kA</p> <p>100 kA</p> <p>10 kA</p>
<b>Breaking capacity short-circuit current (Icn)</b> <ul style="list-style-type: none"> <li>• with 1 current path at DC at 150 V Rated value</li> <li>• with 2 current paths in series at DC at 300 V Rated value</li> <li>• with 3 current paths in series at DC at 450 V Rated value</li> </ul>	<p>10 kA</p> <p>10 kA</p> <p>10 kA</p>
<b>Response value current of the instantaneous short-circuit release</b>	<p>42 A</p>

#### UL/CSA ratings:

<b>Full-load current (FLA) for three-phase AC motor</b> <ul style="list-style-type: none"> <li>• at 480 V Rated value</li> <li>• at 600 V Rated value</li> </ul>	<p>3.2 A</p> <p>3.2 A</p>
<b>yielded mechanical performance [hp]</b> <ul style="list-style-type: none"> <li>• for single-phase AC motor <ul style="list-style-type: none"> <li>— at 110/120 V Rated value</li> <li>— at 230 V Rated value</li> </ul> </li> <li>• for three-phase AC motor <ul style="list-style-type: none"> <li>— at 200/208 V Rated value</li> <li>— at 220/230 V Rated value</li> <li>— at 460/480 V Rated value</li> <li>— at 575/600 V Rated value</li> </ul> </li> </ul>	<p>0.1 hp</p> <p>0.25 hp</p> <p>0.5 hp</p> <p>0.75 hp</p> <p>1.5 hp</p> <p>2 hp</p>
<b>Contact rating of the auxiliary contacts acc. to UL</b>	<p>C600 / R300</p>

#### Short-circuit:

<b>Design of the short-circuit trip</b>	<p>magnetic</p>
<b>Design of the fuse link</b> <ul style="list-style-type: none"> <li>• for short-circuit protection of the auxiliary switch required</li> </ul>	<p>fuse gL/gG: 6 A, quick: 10 A</p>
<b>Design of the fuse link for IT network for short-circuit protection of the main circuit</b> <ul style="list-style-type: none"> <li>• at 400 V</li> <li>• at 500 V</li> <li>• at 690 V</li> </ul>	<p>gL/gG 25 A</p> <p>gL/gG 32 A</p> <p>gL/gG 25 A</p>

#### Installation/ mounting/ dimensions:

<b>mounting position</b>	any
<b>Mounting type</b>	screw and snap-on mounting onto 35 mm standard mounting rail according to DIN EN 60715
<b>Height</b>	97 mm
<b>Width</b>	65 mm
<b>Depth</b>	96 mm
<b>Required spacing</b>	
<ul style="list-style-type: none"> <li>• with side-by-side mounting <ul style="list-style-type: none"> <li>— forwards 0 mm</li> <li>— Backwards 0 mm</li> <li>— upwards 50 mm</li> <li>— downwards 50 mm</li> <li>— at the side 0 mm</li> </ul> </li> <li>• for grounded parts <ul style="list-style-type: none"> <li>— forwards 0 mm</li> <li>— Backwards 0 mm</li> <li>— upwards 50 mm</li> <li>— at the side 30 mm</li> <li>— downwards 50 mm</li> </ul> </li> <li>• for live parts <ul style="list-style-type: none"> <li>— forwards 0 mm</li> <li>— Backwards 0 mm</li> <li>— upwards 50 mm</li> <li>— downwards 50 mm</li> <li>— at the side 30 mm</li> </ul> </li> </ul>	

Connections/ Terminals:	
<b>Product function</b>	
<ul style="list-style-type: none"> <li>• removable terminal for auxiliary and control circuit</li> </ul>	No
<b>Type of electrical connection</b>	
<ul style="list-style-type: none"> <li>• for main current circuit</li> <li>• for auxiliary and control current circuit</li> </ul>	screw-type terminals screw-type terminals
<b>Arrangement of electrical connectors for main current circuit</b>	Top and bottom
<b>Type of connectable conductor cross-section</b>	
<ul style="list-style-type: none"> <li>• for main contacts <ul style="list-style-type: none"> <li>— single or multi-stranded 2x (0,75 ... 2,5 mm<sup>2</sup>), 2x 4 mm<sup>2</sup></li> <li>— finely stranded with core end processing 2x (0.5 ... 1.5 mm<sup>2</sup>), 2x (0.75 ... 2.5 mm<sup>2</sup>)</li> </ul> </li> <li>• for AWG conductors for main contacts 2x (18 ... 14), 2x 12</li> </ul>	
<b>Type of connectable conductor cross-section</b>	
<ul style="list-style-type: none"> <li>• for auxiliary contacts <ul style="list-style-type: none"> <li>— single or multi-stranded 2x (0,5 ... 1,5 mm<sup>2</sup>), 2x (0,75 ... 2,5 mm<sup>2</sup>)</li> </ul> </li> </ul>	



— finely stranded with core end processing	2x (0.5 ... 1.5 mm <sup>2</sup> ), 2x (0.75 ... 2.5 mm <sup>2</sup> )
• for AWG conductors for auxiliary contacts	2x (20 ... 16), 2x (18 ... 14)
<b>Design of screwdriver shaft</b>	Diameter 5 to 6 mm
<b>Design of the thread of the connection screw</b>	
• for main contacts	M3
• of the auxiliary and control contacts	M3

Safety related data:	
<b>B10 value with high demand rate acc. to SN 31920</b>	50 000
<b>Proportion of dangerous failures</b>	
• with low demand rate acc. to SN 31920	40 %
• with high demand rate acc. to SN 31920	40 %
<b>T1 value for proof test interval or service life acc. to IEC 61508</b>	10 y





Mechanical data:	
<b>Size of the circuit-breaker</b>	S00

Display:	
<b>Display version</b>	
• for switching status	Handle



Certificates/ approvals:

General Product Approval	Declaration of Conformity	Test Certificates
 CSA	 EG-Konf.	<a href="#">Typprüfbescheinigung/Werkszeugnis</a> <a href="#">spezielle Prüfbescheinigungen</a>

Shipping Approval

 ABS	 BUREAU VERITAS	 DNV	 GL	 LRS	 PRS
--	---	--	---	--	--

Shipping Approval      other

 RINA	 RMRS	<a href="#">Bestätigungen</a>	<a href="#">Umweltbestätigung</a>	 VDE
---	---	-------------------------------	-----------------------------------	--

Further information

Information- and Downloadcenter (Catalogs, Brochures,...)  
<http://www.siemens.com/industrial-controls/catalogs>

**Industry Mall (Online ordering system)**

<http://www.siemens.com/industrymall>

**Cax online generator**

<http://support.automation.siemens.com/WW/CAXorder/default.aspx?lang=en&mfb=3RV2111DA10>

**Service&Support (Manuals, Certificates, Characteristics, FAQs,...)**

<https://support.industry.siemens.com/cs/ww/en/ps/3RV2111DA10>

**Image database (product images, 2D dimension drawings, 3D models, device circuit diagrams, EPLAN macros, ...)**

[http://www.automation.siemens.com/bilddb/cax\\_de.aspx?mfb=3RV2111DA10&lang=en](http://www.automation.siemens.com/bilddb/cax_de.aspx?mfb=3RV2111DA10&lang=en)

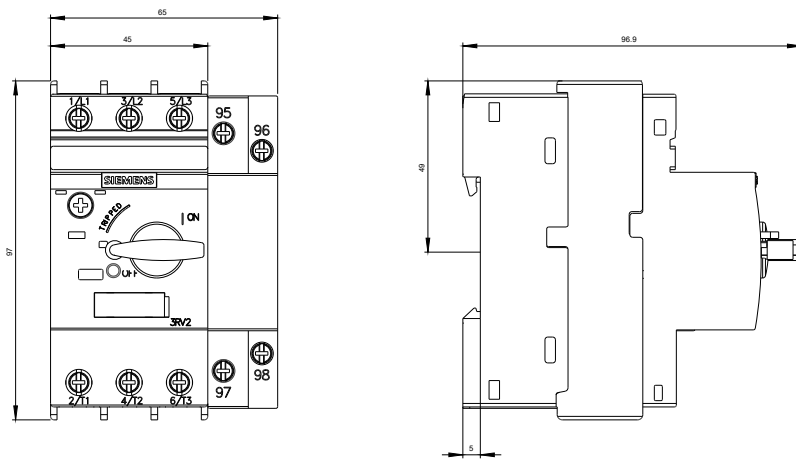

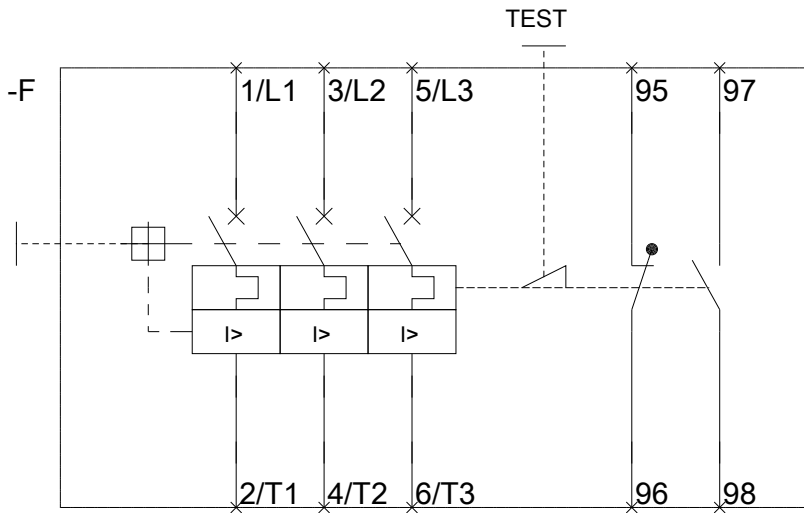
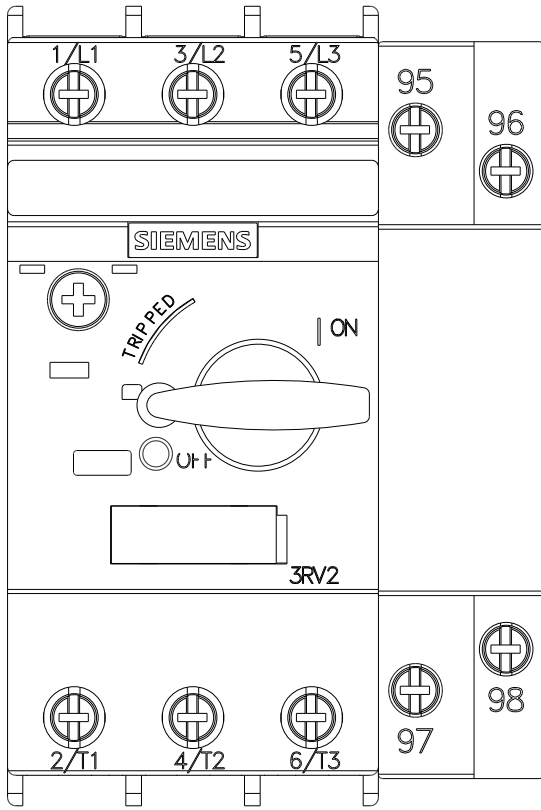

last modified:

29.06.2015