



CIRCUIT-BREAKER SZ S00, FOR MOTOR PROTECTION, CLASS 10, W. OVERLOAD RELAY FUNCTION A-RELEASE 0.7...1A, N-RELEASE 13A, SCREW CONNECTION, STANDARD SW. CAPACITY

product brand name	SIRIUS
Product designation	3RV2 circuit breaker

General technical data:	
Size of contactor can be combined company-specific	S00
Product expansion	
• Auxiliary switch	Yes
Active power loss total typical	6 W
Insulation voltage	
• with degree of pollution 3 Rated value	690 V
Surge voltage resistance Rated value	6 kV
Protection class IP	
• on the front	IP20
• of the terminal	IP20
Mechanical service life (switching cycles)	
• of the main contacts typical	100 000
• of the auxiliary contacts typical	100 000
Electrical endurance (switching cycles)	
• typical	100 000
Temperature compensation	-20 ... +60 °C
Type of protection	Increased safety

Ambient conditions:	
Installation altitude at height above sea level maximum	2 000 m
Ambient temperature	
• during operation	-20 ... +60 °C

<ul style="list-style-type: none"> during storage 	-50 ... +80 °C
<ul style="list-style-type: none"> during transport 	-50 ... +80 °C
Relative humidity during operation	10 ... 95 %

Main circuit:

Adjustable response value current of the current-dependent overload release	0.7 ... 1 A
Operating voltage	
<ul style="list-style-type: none"> Rated value 	690 V
<ul style="list-style-type: none"> at AC-3 Rated value maximum 	690 V
Operating frequency Rated value	50 ... 60 Hz
Operating current Rated value	1 A
Operating current	
<ul style="list-style-type: none"> at AC-3 	
<ul style="list-style-type: none"> — at 400 V Rated value 	1 A
Operating power	
<ul style="list-style-type: none"> at AC-3 	
<ul style="list-style-type: none"> — at 230 V Rated value 	180 W
<ul style="list-style-type: none"> — at 400 V Rated value 	250 W
<ul style="list-style-type: none"> — at 500 V Rated value 	370 W
<ul style="list-style-type: none"> — at 690 V Rated value 	550 W
Operating frequency	
<ul style="list-style-type: none"> at AC-3 maximum 	15 1/h

Auxiliary circuit:

Number of NC contacts	
<ul style="list-style-type: none"> for auxiliary contacts 	0
Number of NO contacts	
<ul style="list-style-type: none"> for auxiliary contacts 	0
Number of CO contacts	
<ul style="list-style-type: none"> for auxiliary contacts 	0
Design of the auxiliary switch	laterally
Operating current of the auxiliary contacts at AC-15	
<ul style="list-style-type: none"> at 24 V 	1.5 A
<ul style="list-style-type: none"> at 230 V 	1.5 A
Operating current of the auxiliary contacts at DC-13	
<ul style="list-style-type: none"> at 24 V 	1 A

Protective and monitoring functions:

Trip class	CLASS 10
Design of the overload circuit breaker	thermal
Operational short-circuit current breaking capacity (Ics) at AC	
<ul style="list-style-type: none"> at 240 V Rated value 	100 kA

<ul style="list-style-type: none"> • at 400 V Rated value • at 500 V Rated value • at 690 V Rated value 	100 kA 100 kA 100 kA
Maximum short-circuit current breaking capacity (Icu)	
<ul style="list-style-type: none"> • at AC at 240 V Rated value • with AC at 400 V Rated value • at AC at 500 V Rated value • at AC at 690 V Rated value 	100 kA 100 kA 100 kA 100 kA
Breaking capacity short-circuit current (Icn)	
<ul style="list-style-type: none"> • with 1 current path at DC at 150 V Rated value • with 2 current paths in series at DC at 300 V Rated value • with 3 current paths in series at DC at 450 V Rated value 	10 kA 10 kA 10 kA
Response value current of the instantaneous short-circuit release	13 A

UL/CSA ratings:

Full-load current (FLA) for three-phase AC motor	
<ul style="list-style-type: none"> • at 480 V Rated value • at 600 V Rated value 	1 A 1 A
yielded mechanical performance [hp]	
<ul style="list-style-type: none"> • for three-phase AC motor <ul style="list-style-type: none"> — at 575/600 V Rated value 	0.5 hp
Contact rating of the auxiliary contacts acc. to UL	C600 / R300

Short-circuit:

Design of the short-circuit trip	magnetic
Design of the fuse link	
<ul style="list-style-type: none"> • for short-circuit protection of the auxiliary switch required 	fuse gL/gG: 6 A, quick: 10 A
Design of the fuse link for IT network for short-circuit protection of the main circuit	
<ul style="list-style-type: none"> • at 500 V • at 690 V 	gL/gG 10 A gL/gG 10 A

Installation/ mounting/ dimensions:

mounting position	any
Mounting type	screw and snap-on mounting onto 35 mm standard mounting rail according to DIN EN 60715
Height	97 mm
Width	65 mm
Depth	96 mm
Required spacing	
<ul style="list-style-type: none"> • with side-by-side mounting 	

— forwards	0 mm
— Backwards	0 mm
— upwards	50 mm
— downwards	50 mm
— at the side	0 mm
• for grounded parts	
— forwards	0 mm
— Backwards	0 mm
— upwards	50 mm
— at the side	30 mm
— downwards	50 mm
• for live parts	
— forwards	0 mm
— Backwards	0 mm
— upwards	50 mm
— downwards	50 mm
— at the side	30 mm

Connections/ Terminals:

Product function	
• removable terminal for auxiliary and control circuit	No
Type of electrical connection	
• for main current circuit	screw-type terminals
• for auxiliary and control current circuit	screw-type terminals
Arrangement of electrical connectors for main current circuit	Top and bottom
Type of connectable conductor cross-section	
• for main contacts	
— single or multi-stranded	2x (0,75 ... 2,5 mm ²), 2x 4 mm ²
— finely stranded with core end processing	2x (0.5 ... 1.5 mm ²), 2x (0.75 ... 2.5 mm ²)
• for AWG conductors for main contacts	2x (18 ... 14), 2x 12
Type of connectable conductor cross-section	
• for auxiliary contacts	
— single or multi-stranded	2x (0,5 ... 1,5 mm ²), 2x (0,75 ... 2,5 mm ²)
— finely stranded with core end processing	2x (0.5 ... 1.5 mm ²), 2x (0.75 ... 2.5 mm ²)
• for AWG conductors for auxiliary contacts	2x (20 ... 16), 2x (18 ... 14)
Design of screwdriver shaft	Diameter 5 to 6 mm
Design of the thread of the connection screw	
• for main contacts	M3
• of the auxiliary and control contacts	M3

Safety related data:

B10 value with high demand rate acc. to SN 31920	50 000
Proportion of dangerous failures	
• with low demand rate acc. to SN 31920	40 %
• with high demand rate acc. to SN 31920	40 %
T1 value for proof test interval or service life acc. to IEC 61508	10 y



Mechanical data:

Size of the circuit-breaker	S00
-----------------------------	-----

Display:

Display version	
• for switching status	Handle

Certificates/ approvals:

General Product Approval	Declaration of Conformity	Test Certificates
 CSA KTL	 EAC  EG-Konf.	Typprüfbescheinigung/Werkszeugnis spezielle Prüfbescheinigungen

Shipping Approval



Shipping Approval

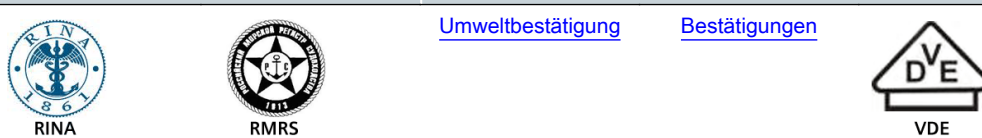

Further information

Information- and Downloadcenter (Catalogs, Brochures,...)

<http://www.siemens.com/industrial-controls/catalogs>

Industry Mall (Online ordering system)

<http://www.siemens.com/industrymall>

Cax online generator

<http://support.automation.siemens.com/WW/CAXorder/default.aspx?lang=en&mlfb=3RV21110JA10>

Service&Support (Manuals, Certificates, Characteristics, FAQs,...)

<https://support.industry.siemens.com/cs/ww/en/ps/3RV21110JA10>

Image database (product images, 2D dimension drawings, 3D models, device circuit diagrams, EPLAN macros, ...)

http://www.automation.siemens.com/bilddb/cax_de.aspx?mlfb=3RV21110JA10&lang=en

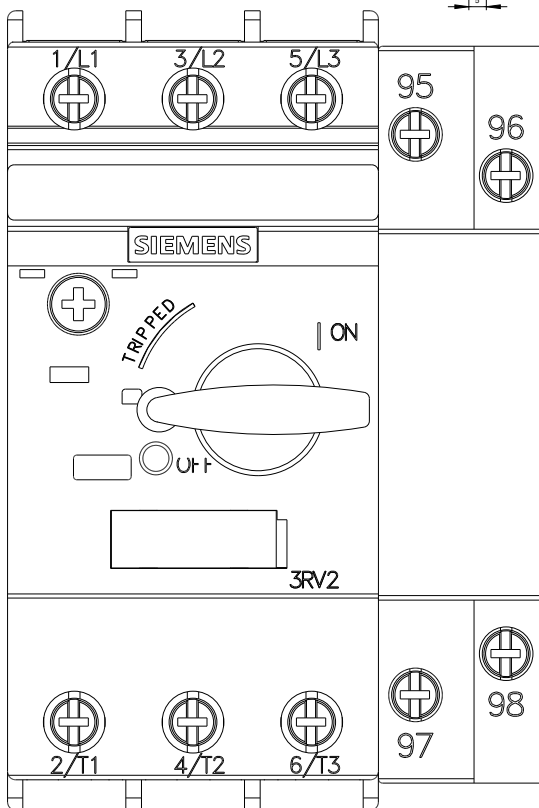
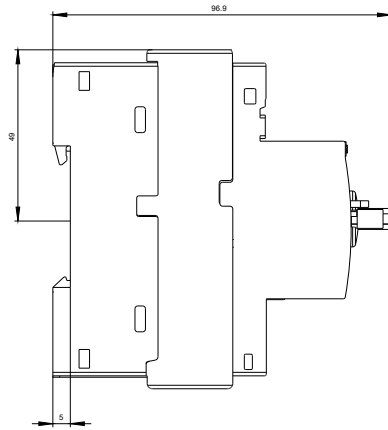
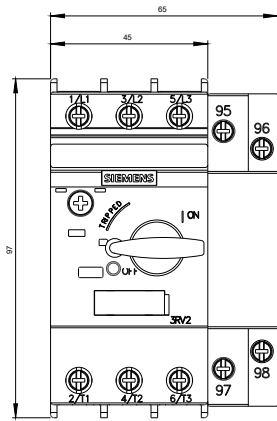

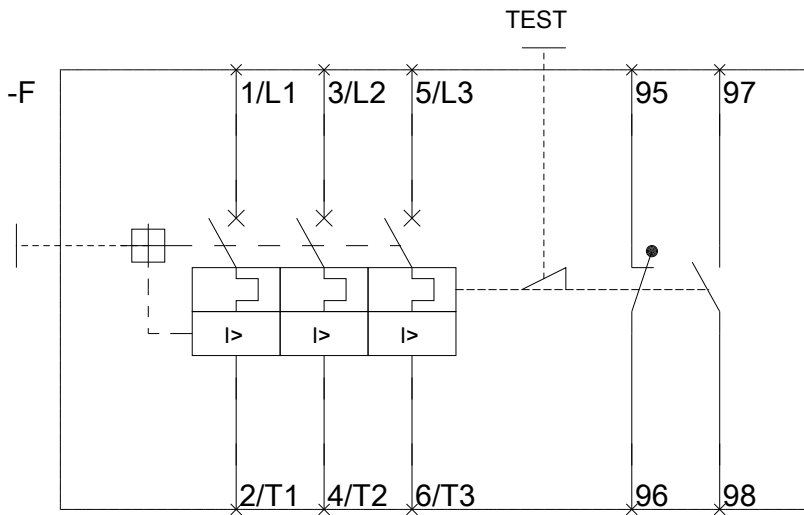

last modified:

29.06.2015