



**Non-reversing motor starter**  
**NEMA controller size 1**  
**3-Phase, 3-Pole**  
**Maximum voltage rating 600VAC**  
**Max Hp 60Hz: 2@200V; 2@230V; 5@460V; 5@575V**  
**Solid-state overload relay(s) with 3–12A range**  
**Control voltage 110VAC 50Hz / 120VAC 60Hz**  
**Open device (no enclosure)**

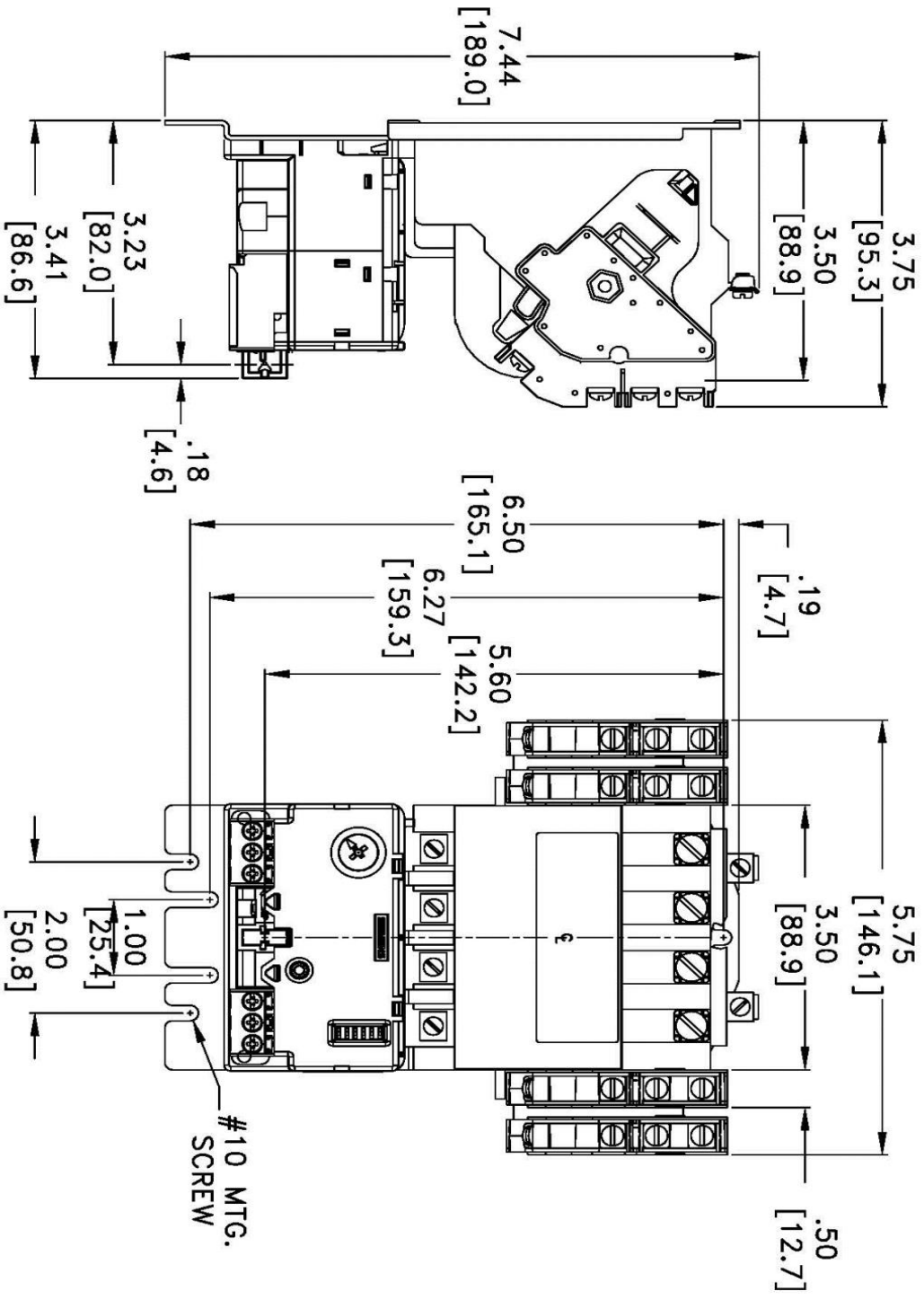

Image is representative and may not depict the actual product.

<b>General technical data:</b>	
Weight	3.4 lb
Height x Width x Depth	7.44 x 5.75 x 3.75 in.
Finger-safe (main circuit / control circuit)	No / No
Maximum altitude	6560 ft
Ambient storage temperature	(-30 to 65)°C / (-22 to 149)°F
Ambient operating temperature	(-20 to 40)°C / (-4 to 104)°F
Humidity (% non-condensing)	(no data)
Rated impulse voltage resistance	(no data)
Rated insulation voltage	(no data)
Country of origin	Mexico
<b>Contactors:</b>	
Number of NO main contacts	3
Amp rating	27A
Mechanical operating cycles	10,000,000
<b>Internal/standard auxiliary contact:</b>	
Number of NC / NO auxiliary contacts	0NC / 1NO
Rating	10A@600VAC (A600), 5A@600VDC (P600)
<b>Optional auxiliary contact:</b>	
Max number of NC / NO auxiliary contacts	8 total
Rating	10A@600VAC (A600), 5A@600VDC (P600)
<b>Coil:</b>	
Voltage	110VAC 50Hz / 120VAC 60Hz Coil
Sealed watts	8.6W
Inrush / sealed power	218 / 25 VA
Normal coil operating limits (% of rated voltage)	85% - 110%
Typical drop-out volts (% of rated voltage)	50%
Pick-up time / Drop-out time	19-29 / 10-24 msec
<b>Overload Relay:</b>	
Current range	3–12A
Trip Class	Class 5 / 10 / 20 (factory set) / 30
Trip detection	Overload, phase failure, phase unbalance, ground fault
Phase failure sensitivity	Trip time after phase-loss: < 3 sec
Repeat accuracy	Within 1%
Reset options	Manual, automatic and remote
External reset	No
Test function	Electronics & manual actuation
Conformal coating on printed circuit board	Yes
Number of NC / NO auxiliary contacts	1NC / 1NO
Rating of auxiliary contacts	5A@600VAC (B600), 1A@250VDC (R300)
Single contact isolation	600V

Dual contact isolation	300V differing polarity / 600V common polarity
<b>Enclosure:</b>	
Type	Open device (no enclosure)
Rating	NA
<b>Mounting/wiring:</b>	
Mounting orientation	Vertical
Mounting type	Surface
Line side connection type / torque	Screw / 35 lb-in.
Line side solid & stranded conductors	1x(14 - 2 AWG) 75°C AL or CU
Load side connection type / torque	Screw / 35 lb-in.
Load side solid & stranded conductors	1x(14 - 2 AWG) 75°C AL or CU
Coil connection type / torque	Screw / 5 lb in. - 12 lb in.
Coil solid & stranded conductors	2 x (16 - 12 AWG) CU 60/75°C
Main auxiliary contact connection type / torque	(no data)
Main auxiliary contact solid & stranded conductors	(no data)
OLR auxiliary contact connection type / torque	Screw / 7 lb in. - 10 lb in.
OLR auxiliary contact solid & stranded conductors	2 x (20 - 14 AWG) CU 60/75°C
<b>Short circuit current rating:</b>	
Fuses	10kA@600V (Class H or K); 100kA@600V (Class R or J)
Thermal Magnetic Circuit Breaker	14kA@240V; 10kA@600V
<b>Certificates/approvals:</b>	
	<a href="#">UL (file no. E14900)</a>
	<a href="#">cUL (file no. E14900 for Canada)</a>
	<a href="#">CSA (file no. LR 6535)</a>
	<a href="#">ISO 9001 certification</a>
<b>Additional information:</b>	
	<a href="#">Brochure</a>
	<a href="#">OLR instruction sheet &amp; trip curves</a>

OUTLINE NEMA SIZE 00 - 1 3/4 CLASS 14 STARTER



DIMENSIONS ARE IN INCHES [MILLIMETERS]  
 FILE NAME: D38235001

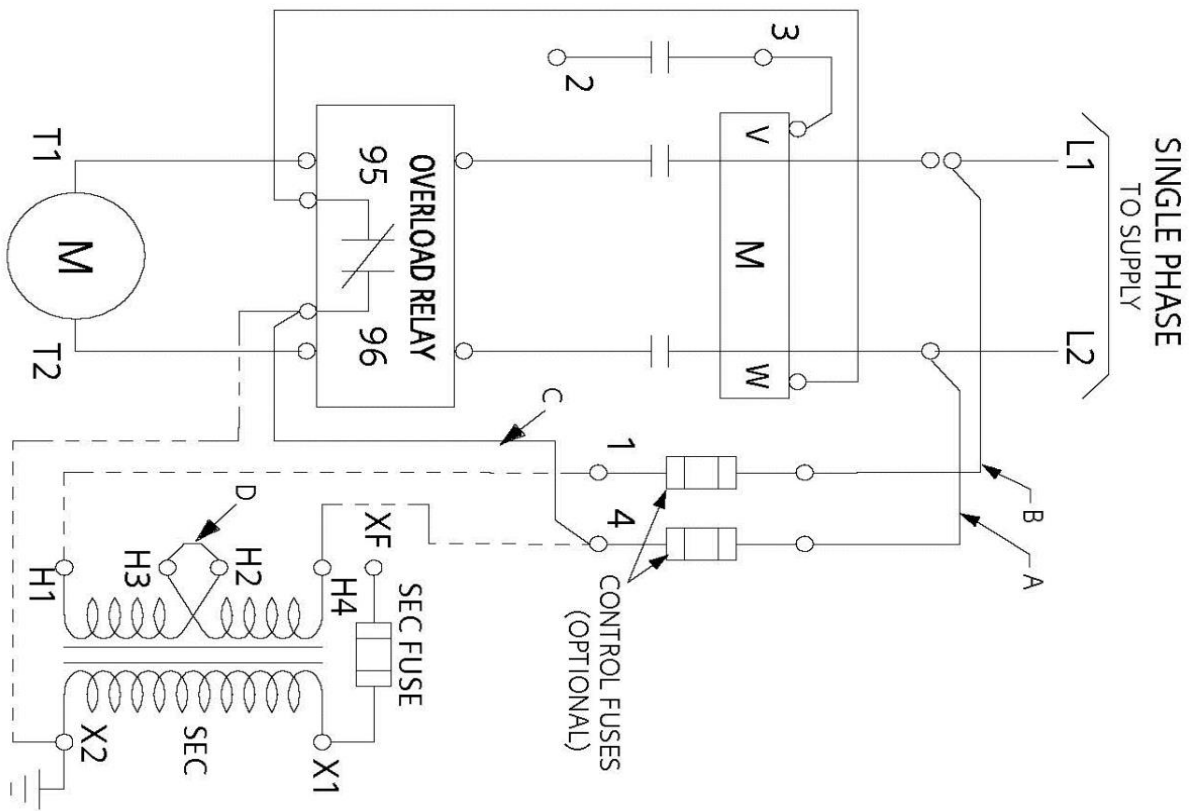
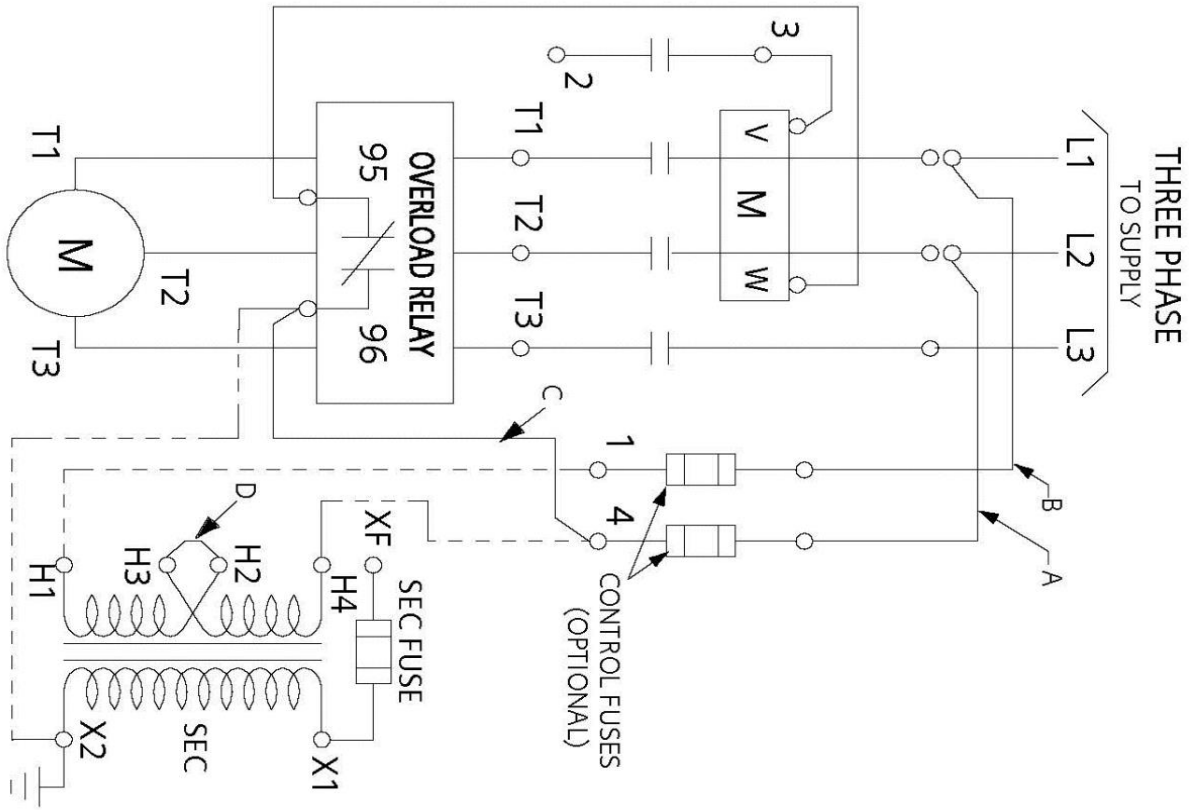

REF. D46590001