

FEATURES & SPECIFICATIONS

INTENDED USE — Recessed housing rated IC or Non-IC. For new construction only.

Approved for all ceiling and wiring types.

Approved for direct burial in insulation.

CONSTRUCTION — Air-Tight standard. Tested to meet current energy codes.

Aluminum housing with galvanized steel pan.

Galvanized bar hangers span up to 24" o.c. and feature built in nailer and integral T-bar clips. Two locking screws hold fixture in position.

Galvanized steel junction box with four built-in Romex clamps; five 1/2" and two 3/4" nominal knockouts with slots for pryout. Rated for through branch wiring.

Maximum 4 (2 in, 2 out) No 12 AWG conductors. Rated for 90° C.

Ground wire provided.

Removable J-box doors for easy access.

Trim retention (clips): Retaining clips riveted to top of reflector hold trim inside housing.

Trim retention (TOR): Two-side mounted torsion springs on the trim and 2 receiving brackets in the can ensure a consistently tight fit with the ceiling.

ELECTRICAL — Durable medium base porcelain socket with nickel plated copper alloy screw shell and contact.

Socket clips to top of housing to prevent paint overspray in socket screw shell.

Socket attaches to reflector to ensure proper and consistent lamp position.

Thermal protection provided against improper lamp usage.

120 volts only.

INSTALLATION — Air-Tight housing suitable for air-tight installations.

2 x 8 wood joist or T-bar installation.

Expandable bar hangers allow for off center mounting in wood joist or T-bar ceilings.

Length of 25 1/4" maximum 13 1/4" minimum or cut to fit 9" on center joist construction.

Vertical adjustment of housing allows for flush mounting with ceiling face.

Suitable to ceilings up to 1-1/2" thick.

LISTINGS — UL Listed to US and Canadian safety standards.

Damp location listing. (See trim selection for wet location listing).

WARRANTY — 1-year limited warranty. Complete warranty terms located at

www.acuitybrands.com/CustomerResources/Terms_and_conditions.aspx

Note: Actual performance may differ as a result of end-user environment and application.

Specifications subject to change without notice.

Catalog Number
Notes
Type

6" Housing

L7X

INCANDESCENT
IC/Non-IC
New Construction

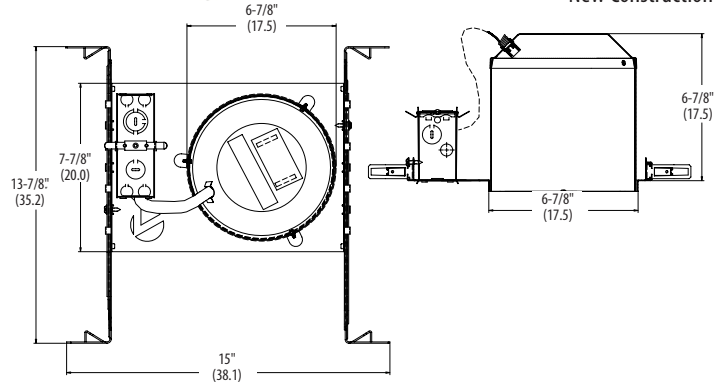

Specifications

Height: 6-7/8 (17.5)

Length: 15 (38.1)

Width: 13-7/8 (35.2)

Ceiling cutout: 7 (17.8)

All dimensions are inches (centimeters) unless otherwise specified.

ORDERING INFORMATION For shortest lead times, configure product using **bolded options**.

Example: L7X R6













Series	Options	Packaging
L7X	Shipped installed in fixture PHC Poke-home wire connectors GSKT Foam gasketing, aids in air-tight installation	R6 Resale pack of six U Unit (non-stock)

Accessories: Order as separate catalog number.	
ATK6 R6	6" Air-tight trim kit
HS6875	6-7/8" hole saw

Notes

See trim summary on reverse side for maximum wattages.

L7X 6" New Construction Housing

Description Catalog number	Maximum wattage ¹	Description Catalog number	Maximum wattage ¹	Description Catalog number	Maximum wattage ¹	Description Catalog number	Maximum wattage ¹
General/Task							
Open Narrow Flange 702 PF 702A 702A PFMW TOR	White with plastic flange Clear diffuse Clear diffuse, matte white, plastic flange Clear specular Black specular	Baffle Narrow Flange 7B2 TOR 7B2 TRMW TOR 7B2W TOR 7B2W PF TOR 7B2MW TOR 7B2BN TOR 7B2ORB TOR	Black Black, matte white flange White White plastic flange Matte white Brushed nickel Oil-rubbed bronze	IC/Non-IC	65 BR30 75 PAR30	IC/Non-IC	65 BR30 75 PAR30
							40 A19
IC/Non-IC		IC/Non-IC		IC/Non-IC		IC	
Open Narrow Flange 702 TOR 702MW TOR 702BN TOR 702ORB TOR	White* Matte white Brushed nickel Oil-rubbed bronze	Baffle Wide Flange 7B3 TOR 7B3W TOR	Black White	IC/Non-IC	65 BR30 75 PAR30	Non-IC	60 A19
				IC/Non-IC			60 A19
IC/Non-IC		IC/Non-IC		IC/Non-IC		Non-IC	
Open Wide Flange 703 TOR	White	Baffle Narrow Flange 7B5 7B5W	Black White	Non-IC	65 BR30 75 PAR30	Non-IC	60 A19 65 BR30 50 R20/PAR20
				Non-IC			60 A19 65 BR30 50 R20/PAR20
IC/Non-IC		Non-IC		Non-IC		Non-IC	
Open Narrow Flange 705 705 PF 705AZ	White White plastic flange Clear specular	Accent/Adjustable		IC/Non-IC	65 BR30 75 PAR30	Lens/Wet Location²	
		Eyeball Wide Flange 7E1 TOR 7E1MW TOR 7E1BN TOR 7E1ORB TOR 7E1BZA TOR		IC/Non-IC	65 BR30 75 PAR30	WETlite™ 6H20 TOR White 6H20ORB TOR Oil-rubbed bronze 6H20BN TOR Brushed nickel	
Non-IC				IC/Non-IC			
		IC/Non-IC		IC/Non-IC		75 PAR38	
						* For plastic flange add suffix PF	
						Notes 1 Maximum wattage listed. Lower wattage lamps may be used. 2 Lens trims and WETlites™ are wet location listed. All others are damp location.	
						Additional Notes • Shallow trims may be used for lower lamp position. See C Series Trims. • 6 C series trims also compatible options. • See LED modules on page 2 and page 3.	

L7X 6" New Construction Housing

REALITY™ ENERGY STAR® (ESL) Open Narrow Flange LED Module (Wet location)



Example: REAL6 D6MW ESL 1000L 35K .60SC L7X¹

ORDERING INFORMATION For shortest lead times, configure products using **bolded options**.

Series/Finish		ESL Type	Lumen output ²	Color temperature	Distribution	Voltage	Options
Series REAL6 D6 6" ENERGY STAR retrofit module	Finish MW Matte white A Clear diffuse AZ Clear specular BN Brushed nickel BLZ Black specular BZA Antique bronze ORB Oil-rubbed bronze WT Wheat diffuse	ESL ENERGY STAR® qualified	600L 8W, 600 lumens	27K 2700 K 30K 3000 K 35K 3500 K 40K 4000 K	.60SC .60 spacing criteria .90SC .90 spacing criteria	(blank) 120V	PFMW Matte white plastic flange ring PFBL Black plastic flange ring ISH Insect shield
			1000L 11W, 1000 lumens				

Notes
 1 L7X housing ordered on a separate line.
 2 Total system delivered lumens.

P Series Open and Baffle Wide Flange LED Modules (Wet Location)



Example: 6BP TRMW LED 27K 90CRI L7X¹

ORDERING INFORMATION Lead times will vary depending on options selected. Consult with your sales representative.

Series/Finish	Lamp	CCT / CRI / W / Lumens ²	Voltage
6BPMW 6" Baffle LED module, matte white	LED	(blank) 3000 K / 83 CRI / 8.9W / 620L	(blank) 120V
6BP TRMW 6" Baffle LED module, black baffle, matte white flange		27K 90CRI 2700 K / 93 CRI / 11.2W / 600L	
6BPBN 6" Baffle LED module, brushed nickel		30K 90CRI 3000 K / 93 CRI / 11.2W / 600L	
6BPORB 6" Baffle LED module, oil-rubbed bronze		40K 90CRI 4000 K / 92CRI / 9.9W / 650L	
60PA 6" Open LED module, clear diffuse	HL LED	(blank) 3000 K / 83 CRI / 15.2W / 950L	
60PAZ 6" Open LED module, clear specular		27K 90CRI 2700 K / 93 CRI / 16.5W / 860L	
60PA TRMW 6" Open LED module, clear diffuse, matte white flange		30K 90CRI 3000 K / 93 CRI / 16.5W / 860L	
60PAZ TRMW 6" Open LED module, clear specular, matte white flange		40K 90CRI 4000 K / 92CRI / 16.4W / 950L	

Notes
 1 L7X housing ordered on a separate line.
 2 Total system delivered lumens.

E Series Baffle Wide Flange LED Modules (Wet Location)



Example: 65BEMW LED 27K L7X¹

ORDERING INFORMATION For shortest lead times, configure products using **bolded options**.

Series/Finish	Lamp	CCT / CRI / W / Lumens ²	Voltage
65BEMW 5" / 6" Baffle LED module, matte white	LED	27K 2700 K / 82CRI / 11.9W / 640L	(blank) 120V
		30K 3000 K / 82CRI / 11.9W / 687L	
		40K 4000 K / 82CRI / 11.9W / 711L	
		27K 90CRI 2700 K / 93CRI / 10.3W / 650L	
		30K 90CRI 3000 K / 93CRI / 10.1W / 690L	
		40K 90CRI 4000 K / 93CRI / 10.4W / 770L	

Notes
 1 L7X housing ordered on a separate line.
 2 Total system delivered lumens.



L7X

L7X 6" New Construction Housing

LED Gimbal Module (Damp location)



Example: 6G1MW LED L7X¹

ORDERING INFORMATION

For shortest lead times, configure products using **bolded options**.

6G1		LED					
Series/Finish		Lamps		CCT / CRI / W / Lumens ³		Voltage	
<u>Series</u>	<u>Finish</u>	LED		(blank) 3000 K / 83CRI / 10.8W / 620L		(blank) 120V	
6G1	6" Gimbal Module	MW	Matte white	27K 90CRI	2700 K / 91CRI / 11W / 680L		
		MB	Matte black ²	30K 90CRI	3000 K / 91CRI / 10.3W / 790L		
		BN	Brush nickel ²	40K 90CRI	4000 K / 94CRI / 10.5W / 820L		
		ORB	Oil-rubbed bronze ²				

Notes

- 1 L7X housing ordered on a separate line.
- 2 Available in 30K 83CRI only.
- 3 Total system delivered lumens.

LED iGimbal Module (Damp location)



Example: 6iG MW LED 30K 90CRI L7X

ORDERING INFORMATION

For shortest lead times, configure products using **bolded options**.

6iG		LED					
Series/Finish		Lamps		CCT / CRI / W / Lumens ²		Voltage	
<u>Series</u>	<u>Finish</u>	LED		27K 90CRI 2700 K / 92CRI / 11.9W / 720L		(blank) 120V	
6iG	6" Gimbal Module	MW	Matte white	30K 90CRI	3000 K / 92CRI / 12.2W / 750L		
		MB	Matte black	40K 90CRI	4000 K / 95CRI / 11.6W / 770L ³		
		BN	Brush nickel ¹				
		ORB	Oil-rubbed bronze				

Notes

- 1 Minimum 90-day lead time for non-standard color finishes; minimum 50-piece order quantity.
- 2 Total system delivered lumens.
- 3 Minimum 90-day lead time for 4000 K color temperature; minimum 50-piece order quantity.