

e2XHD Fiber Cassettes

APPLICATION

The e2XHD Patching System, an easy-to-connect, high-density solution, provides simple termination and improved cable routing for both fiber and copper applications. Cassettes quickly snap-in and pull out of the e2XHD high-density panels, making installation easier than ever. Fiber cassettes are custom configurable and arrive pre-terminated.



e2XHD MTP-LC
24-Fiber Core Cassette



e2XHD MTP-LC
12-fiber Core Cassette



e2XHD MTP-MTP
Edge Cassette
(3x8-fiber to
1x24-fiber)



e2XHD MTP
Pass-through
Cassette



e2XHD QuickPort® LC
12-fiber Cassette, OM3

SPECIFICATION

Fiber cassettes shall snap into rear of panel and shall require no tools to remove. Fiber cassettes shall accept 12 fibers in QuickPort LC, 12 or 24 fibers in MTP-LC, and 24 fibers in MTP-MTP. Cassettes shall meet all ANSI/TIA 568-C.3 requirements and support IEEE 802.3ba standard for 10/40/100GbE.

Page 1 of 3

FEATURES

- OM3, OM4, OM4+, or OS2 available for cassettes
- OM4+ violet helps manage cable plant patching requirements
- 24-fiber is compatible with the Opt-X® Unity 40/100G System
- Alignment tabs on panel ensure upright insertion of cassettes
- To remove cassettes from panel, simply pull on back handle
- Custom configurable through Leviton's Make-to-Order program
- A QuickPort® Connector Removal Tool is available to remove QuickPort connectors from cassettes
- MTP adapters swivel to three positions for easier cable routing:



DESIGN CONSIDERATIONS

- Panels hold up to 48 duplex fiber channels per rack unit (1RU and 4RU e2XHD flat and angled panels available)
- Panel accepts up to eight copper and/or fiber cassettes (12-fiber LC-MTP, 24-fiber MTP-MTP), or four 24-fiber LC-MTP
- Fiber cassettes available in 12- or 24-fiber options and work with pre-terminated 12- or 24-fiber MTP trunks
- TIA Method B polarity installations require one core cassette for each edge cassette; white fiber cassettes designate edge, and black designate core

PHYSICAL SPECIFICATIONS

Materials: Cold-rolled steel and high performance plastics
Capacity: 6 or 12 duplex LC fiber adapters, or 3 8-fiber MTP

STANDARDS COMPLIANCE

- Fiber cassettes meet ANSI/TIA-568-C.3 requirement, support IEEE 802.3ba standard for 10/40/100GbE

PERFORMANCE SPECIFICATIONS

FIBER CASSETTE INSERTION LOSS				
	Multimode		Single-mode	
	12-fiber Max IL	24-fiber Max IL	Typical IL	Max IL
MTP-LC	0.50	0.50	0.60	1.00
MTP-MTP	0.75	0.75	—	—

WARRANTY INFORMATION

For a copy of Leviton product warranties, visit www.leviton.com.

COUNTRY OF ORIGIN

USA

Leviton Network Solutions
2222 - 222nd St. SE
Bothell, WA 98021-4416

Asia / Pacific
T +1.631.812.6228
E infoasean@leviton.com

Canada
T +1.514.954.1840
E pcservice@leviton.com

Caribbean
T +1.954.593.1896
E infocaribbean@leviton.com

China
T +852.2774.9876
E infochina@leviton.com

Colombia
T +57.1.743.6045
E infocolombia@leviton.com

tel 1-800-824-3005
1-425-486-2222
appeng@leviton.com
www.leviton.com

Europe
T +33.6.8869.1380
E infoeurope@leviton.com

India / SAARC
T +91.80.4322.5678
E infoindia@leviton.com

Mexico
T +52.55.5082.1040
E lsamarketing@leviton.com

Middle East & Africa
T +971.4.886.4722
E lmeinfo@leviton.com

South Korea
T +82.2.3273.9963
E infokorea@leviton.com

ELECTRONIC FILES

For CAD files, typical specs, or technical drawings (.DXF, .DWG), visit www.leviton.com.

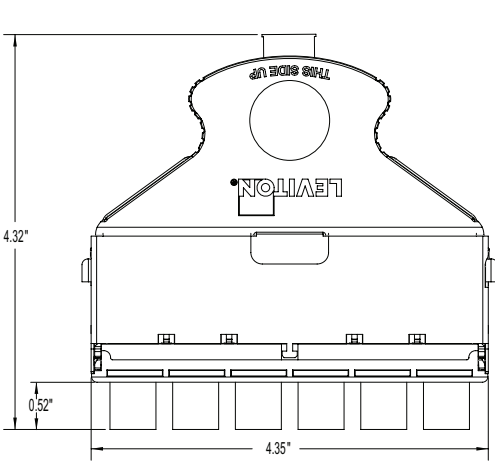

e2XHD MTP®-LC
 24-Fiber Cassette

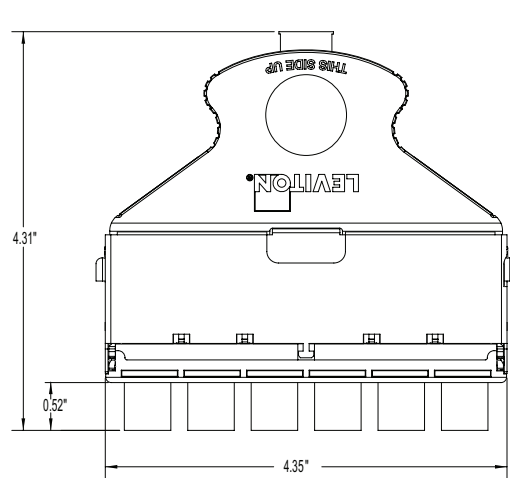
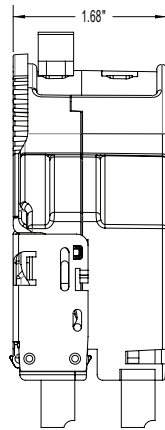

e2XHD MTP-LC
 12-fiber Cassette

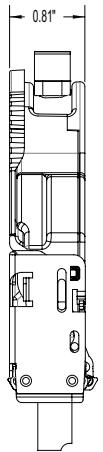

e2XHD MTP Fiber Cassette

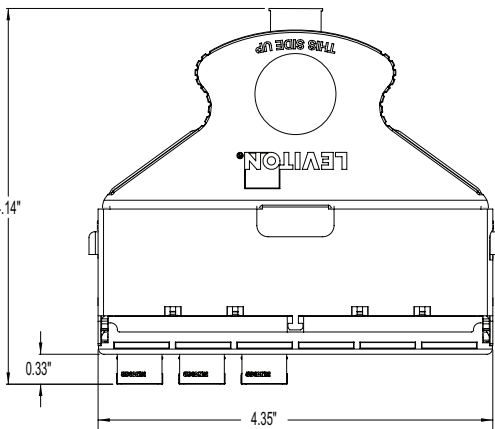
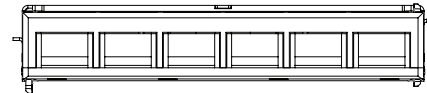
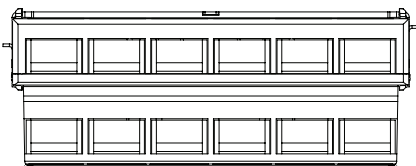

e2XHD MTP-MTP
 Fiber Cassette
 (3x8-fiber to
 2x12-fiber)

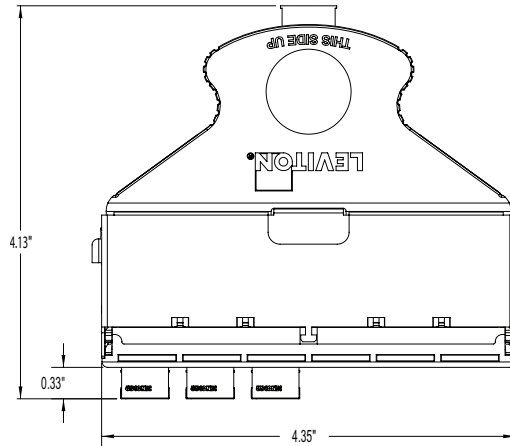
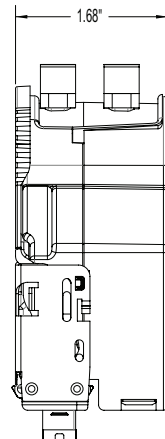

e2XHD MTP-MTP
 Fiber Cassette
 (3x8-fiber to
 1x24-fiber)

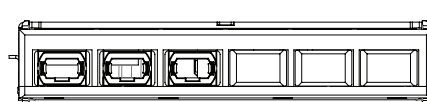
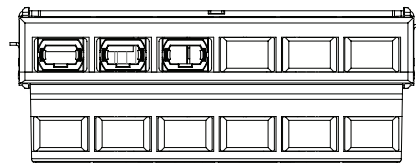
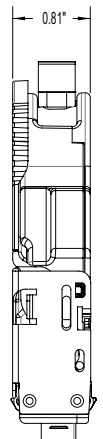

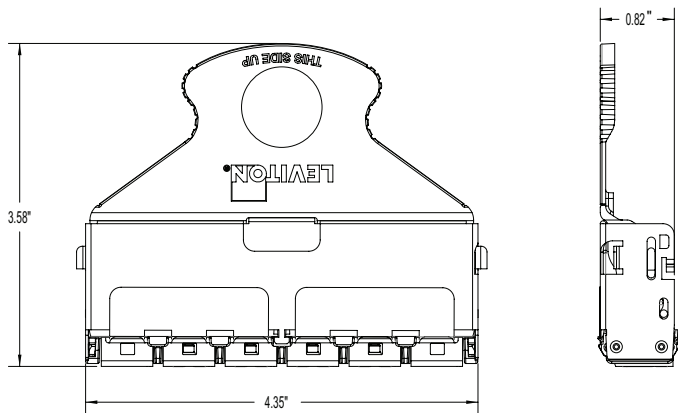

QuickPort® Connector Removal Tool
Removes QuickPort modular copper connectors and fiber adapters from cassettes.

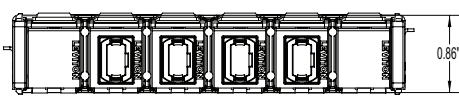

e2XHD MTP®
Pass-through
Cassette

e2XHD 1RU & 4RU PANEL CAPACITY WITH 24-FIBER MTP CABLING

APPLICATION	MAX # OF FIBERS		MAX # OF CHANNELS	
	1RU	4RU	1RU	4RU
10GbE	96	384	48	192
40GbE	192	768	24	96
100GbE	768	3072	32	128

e2XHD MTP Fiber Cassettes

e2XHD Fiber Cassettes	
DESCRIPTION	PART NO.
e2XHD 24-fiber MTP®-LC Fiber Cassette, Core	(see options below)
e2XHD 12-fiber MTP-LC Fiber Cassette, Core	(see options below)
e2XHD MTP-MTP Fiber Cassette, Core	(see options below)
e2XHD 24-fiber MTP-LC Fiber Cassette, Edge	(see options below)
e2XHD 24-fiber MTP-MTP Fiber Cassette, Edge	(see options below)
e2XHD 12-fiber MTP-MTP Fiber Cassette, Edge	(see options below)
e2XHD 12-fiber QuickPort® LC Cassette, OM3 - aqua	E2XLC-AQU
e2XHD 12-fiber QuickPort LC Cassette, OS2 - blue	E2XLC-BLU
e2XHD MTP-MTP Pass-Through Cassette, four key-up/key-down adapters	E2XHD-4MP
e2XHD MTP-MTP Pass-Through Cassette, four key-up/key-up adapters	E2XHD-4MB
QuickPort Connector Removal Tool	E2XHD-JRT

Make-to-Order! e2XHD MTP Fiber Cassette Options

FIBER TYPE	FIBER COUNT	CONNECTOR TYPE	MTP FIBER COUNT	COLOR	FOOTPRINT	POLARITY
<ul style="list-style-type: none"> • OM3 • OM4 • OM4+ • OS2 	<ul style="list-style-type: none"> • 12 • 24 	<ul style="list-style-type: none"> • LC • 8F MTP (female) 	<ul style="list-style-type: none"> • 12F MTP • 24F MTP 	<ul style="list-style-type: none"> • MM aqua adapter • MM violet adapter • SM blue adapter • Black (MTP only) 	<ul style="list-style-type: none"> • 12 Fiber (single cassette height) • 24 Fiber (double cassette height) 	<ul style="list-style-type: none"> • Method A • Method B, Core, black • Method B, Edge, white • Method C



For assistance customizing your cassettes, please visit leviton.com/configurator or call Tech Support at 800.824.3005.

4976 E14

Leviton Network Solutions 2222 - 222nd St. SE Bothell, WA 98021-4416 tel 1-800-824-3005 1-425-486-2222 appeng@leviton.com www.leviton.com	Asia / Pacific T +1.631.812.6228 E infoasean@leviton.com	Canada T +1.514.954.1840 E pcservice@leviton.com	Caribbean T +1.954.593.1896 E infocaribbean@leviton.com	China T +852.2774.9876 E infochina@leviton.com	Colombia T +57.1.743.6045 E infocolombia@leviton.com
	Europe T +33.6.8869.1380 E infoeurope@leviton.com	India / SAARC T +91.80.4322.5678 E infoindia@leviton.com	Mexico T +52.55.5082.1040 E isamarketing@leviton.com	Middle East & Africa T +971.4.886.4722 E lmeinfo@leviton.com	South Korea T +82.2.3273.9963 E infokorea@leviton.com