

## UL 1686 C1 Pin and Sleeve

60A, 600/250V AC/DC, 4 Pole, 5 Wire

## Reversed Service Insulgrip® Receptacle

### Features

- Closure cap with neoprene gasket provides a 4X watertight seal while not in use
- All brass sleeve contacts provide reliable electrical contact with mating pins
- O-Rings provide a watertight and dust tight seal around sleeves negating contamination to the wire chamber
- Catalog number and rating are visible while in use, color coded for Style 1 or Style 2

### Ordering Information

Description	UPC	Catalog Number
Watertight Insulgrip Receptacle, Reversed Service	783585012575	HBL560RS1WR
Device Color	Grounding Style	
Aluminum	Style 1	

### Standards

UL Standard 1682  
CSA Certified to CSA Spec. C22.2 No. 182.1  
UL Listed and CSA Certified Type 4X

### Specifications

Housing	Epoxy Painted Aluminum
Gaskets & Seals	Neoprene
Contact Carrier	Thermoset Polyester
Pin Spring	Beryllium Copper

### Performance

Electrical	
Current Interrupting	Certified for current interrupting at full rated current
Dielectric Voltage	Withstands 3,000V AC
Max. Working Voltage	600V AC RMS
Mechanical	
Impact Resistance	Per CSA C22.2, No. 182.1, UL 1682
Product Identification	Identification and ratings are permanently fastened to the device housing
Terminal Identification	Terminals identified in accordance with UL 1686(1, 2, 3, Green)
Environmental	
Flammability (Enclosure)	UL 94V-0 and CSA C22.2 No. 0.17
Moisture Resistance	Type 3, 4, 4X per UL 50E and CSA 22.2, No. 94
Operating Temperatures	Max. Continuous 75°C; Min. -40°C w/o impact -25° with impact

### Online Resources

Customer Use Drawing  
eCatalog  
Installation Instructions

# HUBBELL

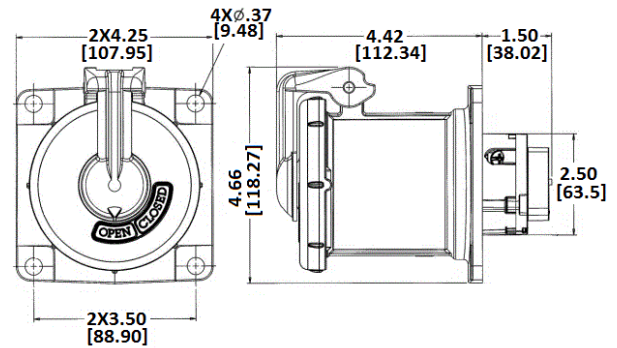

Dimensions in Inches (mm)

Hubbell Wiring Device-Kellems • Hubbell Incorporated (Delaware) • 40 Waterview Drive • Shelton, CT 06484

Phone (800) 288-6000 • Fax (800) 255-1031 • Specifications subject to change without notice.

