

WHY TEST?

PROTECTING YOU FROM WHAT YOU DIDN'T SEE COMING

According to the Center for Disease Control, there are more than 10,000 eye injuries in the USA every day. The Department of Labor has reported that approximately 2,000 of these injuries require medical treatment and time off work, and the Bureau of Labor says 85% of these cases require up to 5 days off work.

While it is not surprising that eye injuries happen on the job site, many are shocked to learn 63% of all eye injuries happen away from work; 47% at home and 16% while playing sports. In an effort to decrease these statistics, the American National Standards Institute (ANSI) created a series of voluntary tests that determine the durability of safety eyewear.

Shown here are some of the many tests required by ANSI and Military Combat Eye Protection Systems (MCEPS). Protective spectacles must pass all of these tests, and more, to be considered compliant with current ANSI and/or MCEPS standards. All Edge Eyewear glasses are independently tested by the accredited COLTS Laboratories.



STANDARDS

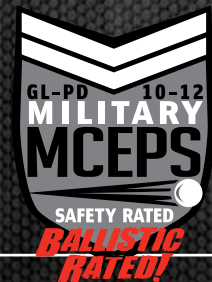

WHAT IS ANSI Z87.1+2010?

Z87.1+2010 is the American National Standards Institute's (ANSI) most current standard for high impact eye protection. In 1922, the War Department, Navy Department, and National Bureau of Standards created the first edition of the Z2 Standard for eye and head protection. Over many decades, these testing standards have been revised, improved, and renamed – resulting in today's ANSI Z87.1-2010 requirements, which are later enforced by OSHA. Edge Eyewear has added a "+" to our Z87.1 markings to indicate that our eyewear is compliant with the high impact level of the standard, which is referred to as "Z87+".

WHAT IS MILITARY MCEPS GL-PD 10-12? (BALLISTIC STANDARD)

The current Military Combat Eye Protection Systems (MCEPS) standard is called MCEPS GL-PD 10-12 which superseded the MIL-PRF-31013 standard in April of 1996. This standard contains ballistic fragmentation tests that determine eyewear compliance. The Military MCEPS standard contains a series of tests that are much more intense than ANSI, to simulate projectiles and dangers faced in combat.

HIGH IMPACT TESTS (+)

Shown here are some of the many tests required for compliance with the ANSI standard.

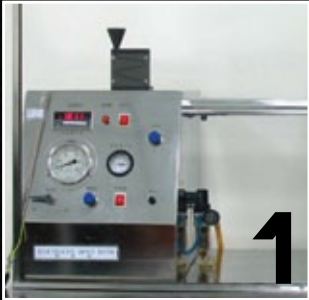

150 ft/s (102 mph): ANSI Z87.1+2010

660 ft/s (450 mph): Military MCEPS GL-PD 10-12



HIGH VELOCITY IMPACT TEST

Spectacle frames and lenses must be capable of resisting impact from a 6.35 mm (.25 in) diameter steel ball traveling at a velocity of 45.72 m/s (150 ft/s).

(ANSI Handbook: Section 6.2.3)

MILITARY MCEPS TEST

The process applied in the High Velocity Impact test is used, but the speed is increased to 660 ft/s.

* MILITARY MCEPS TEST : 660 FT/S SIMULATES A SHOTGUN BLAST FROM 33 FEET

* Often referred to as "BALLISTIC" standard



Scan to Watch
Shotgun Video



HIGH MASS IMPACT TEST

Spectacle frames and lenses must be capable of resisting a 500 g (17.6 oz) spike dropped from a height of 127 cm (50 in).

(ANSI Handbook: Section 6.2.2)

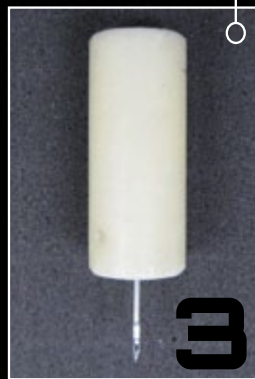

PENETRATION TEST

Lenses must be capable of resisting penetration by a weighted needle with a total weight of 44.2 g (1.56 oz) dropped from a height of 127 cm (50 in).

(ANSI Handbook: Section 6.2.4)

WHAT CONSTITUTES A FAILURE?

When each type of test is conducted as indicated in ANSI Handbook Sections 6.2.2, 6.2.3, and 6.2.4, a complete device will fail if any of the following occurs:

- Fracture of the lens
- Penetration of the rear surface of the lens
- A piece fully detaches from the inside of the spectacle
- Lens is not retained by the frame
- Lens and/or frame touches the eye area, even if the glasses remain intact



Diagram of High
Mass Impact and
Penetration Tests

OPTICAL TESTS

Shown here are some of the many tests required for compliance with the ANSI standard.

RESOLVING POWER TEST

This test of focus measures the ability of a lens to form separate, distinct images of objects that are close together when viewed from 35 ft. away.

What constitutes a failure?

Inability to distinguish three separate lines at the **20-line mark** on an NBS pattern, both vertically and horizontally.

(ANSI Handbook: Section 5.1.4)

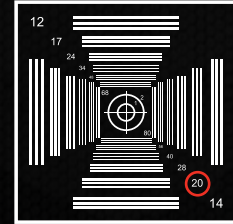

1

LUMINOUS TRANSMISSION TEST

This is an examination that measures Visual Light Transmission (VLT), which is the percentage of light that passes through a lens.

Requirements:

Clear: Must have a minimum of 85% VLT

Tinted: Must have a minimum of 8% and a maximum of 85% VLT

(ANSI Handbook: Sections 5.1.2 & 7.1.2)

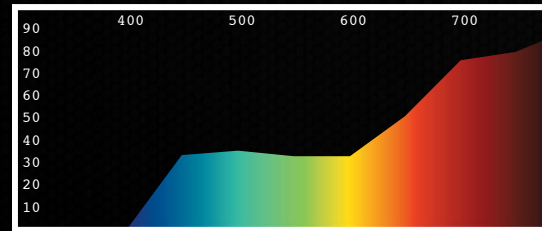

2

ASTIGMATISM TEST

This test looks for improper lens curvature or flat areas that create a refractive power and/or cause image shifting.

What constitutes a failure?

≥ .06 diopters difference

(ANSI Handbook: Section 5.1.4)

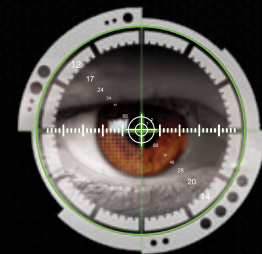

3

PRISMATIC POWER TEST

This test measures the angular deviation of a light ray after it passes through a lens. This is similar to the way light refracts and bends through a prism, causing images to shift.

What constitutes a failure?

≥ .5 diopters of deviation

(ANSI Handbook: Section 5.1.4)

(ANSI Handbook: Section 5.1.4)

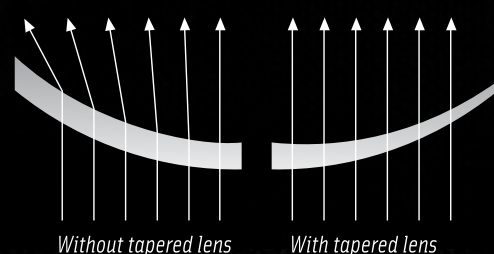

4

REFRACTIVE POWER TEST

This optical clarity (focus) test measures the ability of a lens' entire surface area to focus on the rays of a sunburst pattern without blurring, blending, or bending the lines.

What constitutes a failure?

Refraction of light ± .06 diopters

(ANSI Handbook: Section 5.1.4)

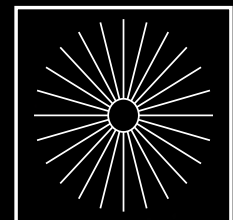

5

TASK & FIT SOLUTIONS

ALL EDGE EYEWEAR INCLUDES:

TPR TECHNOLOGY

Thermoplastic rubber (TPR) is a soft and pliable compound that increases its "grip" as it becomes warm or moist from perspiration. This technology is used in temple tips and nose pads to prevent slipping and keeps glasses on the face.

LENS TECHNOLOGY

Tapered lenses eliminate refraction

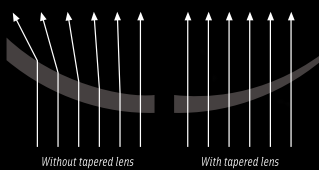

- Lenses filter 99.9% of UVA/UVB/UVC rays
- Fog resistant lenses improve visibility
- Triple dipped anti-scratch coating
- Polycarbonate lenses comply with:
 - ANSI Z87.1+2010
 - Military MCEPS GL-PD 10-12

FRAME TECHNOLOGY

- Frames are made with a flexible and durable TR90/Nylon compound material
- Wrap-around frame has no side shield distortion
- Straight temple arms rest comfortably on the head and don't pinch



OPTIONAL FEATURES:



VAPOR SHIELD ANTI-FOG

Most situations can be handled with a standard Anti-Fog lens, but for extreme environments, Edge Eyewear developed a revolutionary, military grade anti-fog coating called "Vapor Shield." It is absolutely impervious to fog.

VAPOR SHIELD LENSES HAVE PASSED THE FOLLOWING LABORATORY TESTS:

- -44°F for 15 minutes
- Transition from -44°F to 76°F
- 125°F with 80% humidity



STANDARD ANTI-FOG

Anti-Fog coating offers increased clarity in humid, hot, or cold circumstances.

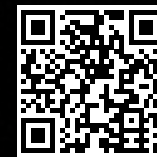

To see Vapor Shield in action scan or visit:

youtube.com/theEdgeEyewear



MAGNIFIERS

Safety means more than just covering the eyes; it is also about optical clarity. Edge Eyewear's bifocal reading glasses are perfect for detailed work and viewing finite details. They are available in three magnification powers (1.5, 2.0, and 2.5) and with polarized lens technology.



We know that safety is more than simply covering your eyes. It is also about how clearly you see clearly.



FOAM GASKET LINING

A foam gasket is essential to safety in environments with high levels of airborne debris, dust, or wind. By creating a "seal", this technology keeps foreign particles out of the glasses and away from the eyes.



XL (WIDE FIT)

Head size varies from person to person, and certain glasses can present a problem for larger heads; some people find standard-sized glasses to be too small on the face or tight in the temples. The solution is a wider frame that not only feels comfortable, but also looks natural.

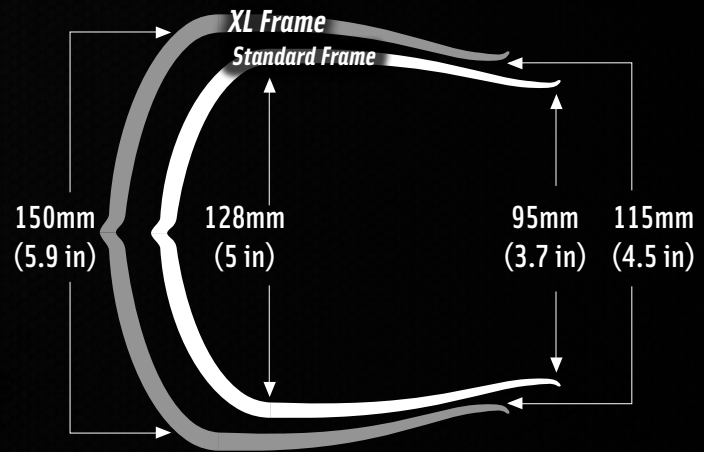

ASIAN FIT

Asian Fit glasses are specifically designed to fit a variety of facial and nose bridge structures. With the addition of an adjustable nosepiece, a perfect fit can be achieved by bending each flexible nose pad inward, outward, forward, or backward.



ISLANDER FIT

Islander Fit glasses combine the Asian Fit's adjustable nose pads with an XL frame. This fit is ideal for those who have larger facial structures and require the addition of a nosepiece that can be modified.



WELDING

Welders, cutting torches, germicidal lamps, and other man-made UV sources can expose the eyes to UVC rays, the most harmful type of ultraviolet radiation. Edge Eyewear's welding lenses protect the cornea from intense, long-term exposure to infrared light.



FIT OVER R_x

Visual clarity is essential to safety, and for some, a magnifier lens isn't enough to read or see finite details. Edge Eyewear's larger safety glasses comfortably fit over prescription glasses.



LADIES STYLE

Ladies glasses are designed to meet fashion standards for women, while also maintaining their safety rating. Edge ladies glasses won't ride on the cheekbones, won't touch the eyelashes, and are made with materials that will not snag the hair.

DAKURA



SW112CF

POLARIZED CAMO



TSM215CF
Polarized
Copper "Driving"



TSM216CF
Polarized Smoke

STANDARD CAMO



SW111CF
Clear



SW112CF
Yellow



SW115CF
Copper "Driving"



SW116CF
Smoke

SILVER



SW126
Smoke



SW128
Blue Mirror

FLAME



SW116F
Smoke

PATENT PROTECTED

ALL MODELS AVAILABLE WITH A
PRE-APPLIED FOAM GASKET pages 48-49

FOAM GASKET KITS
AVAILABLE page 50

DAKURA 35