



AMERICAN LIGHTING

BRIGHT IDEAS • INNOVATIVE PRODUCTS

To Our Valued Customers,

American Lighting is committed to providing you with the highest quality residential and commercial lighting products and unsurpassed customer service in 2004 and beyond. All of our products are thoroughly tested at our manufacturing sites and by our in-house experts to ensure the highest performance standards. Superior customer service and innovative product designs set American Lighting apart from the competition. We are proud of our same day shipping policy for orders received by 2 p.m. (MST) and our low minimum order quantity requirements.

In order to serve our diverse customer base, from lighting showrooms to electrical distributors, designers and specifiers, American Lighting offers our customers the flexibility of placing orders from our catalog or custom orders direct from our factories. We are pleased to offer our esteemed customers a broad range of the finest quality products and the latest in technologies available in the lighting industry. American Lighting understands that innovation is a key strategic advantage for our customers and we are committed to unveiling new products on a continuous basis.

Thank you for choosing American Lighting. We greatly appreciate your business.

Sincerely,

David G. Wilkins
President/CEO



AMERICAN LIGHTING
BRIGHT IDEAS • INNOVATIVE PRODUCTS



Contents

Accent and Task Lighting Systems	4
Illumishelf	5
Clear Channel	6
Brite-Line	6
Xenon 120V Under Cabinet Light	7
Halogen 120V Under Cabinet Light	8
Xenon 120V Puck Light	8
Halogen 120V Puck Light	9
Xenon 12V Puck Light	9
Halogen 12V Puck Light	10
Fluorescent Task Light	10
Ultra-Thin Fluorescent Light	11
Adjustable Fluorescent Light	11
Linear Lighting Systems	12
Radiance Series	13
X-Cove Light	14
Tape Light	14
Rope Light	15
Chasing Rope Light	15
Crystal Tube Light	16
Clip Light	16
Festoon Light String	17
Festival Lights	17
Light Strings (Commercial Grade)	18
Belt Light	18
Fiber Optic Lighting	19
LED Lighting Systems	20
LED Flexbrite	21
LED Mini-Flex	21
LED Clip Light Bulbs	22
LED Festoon Bulbs	22
LED MR16's	22
LED Tube Light	23
LED Mini Light Strings	24
LED Edgelit Signage	24
LED Night Lites	25
Lighting Control Systems	26
Magnetic Transformers	27
Electronic Transformers	27
Plug-in Electronic Transformers	28
Dimmers	29
Touch Control Dimmers	29
Lighting Controls-Photocells	30
Controllers	30
Decorative Plant Light	31
Decorative Up Light	31
Long Life Bulbs	32
MR16 Attachments	32
Bulb Specifications	33
Photometric Data	34
Universal Accessories	35



Accent and Task Lighting Systems



Illumishelf

Illuminating beautiful glass art pieces and collectibles has never been easier!

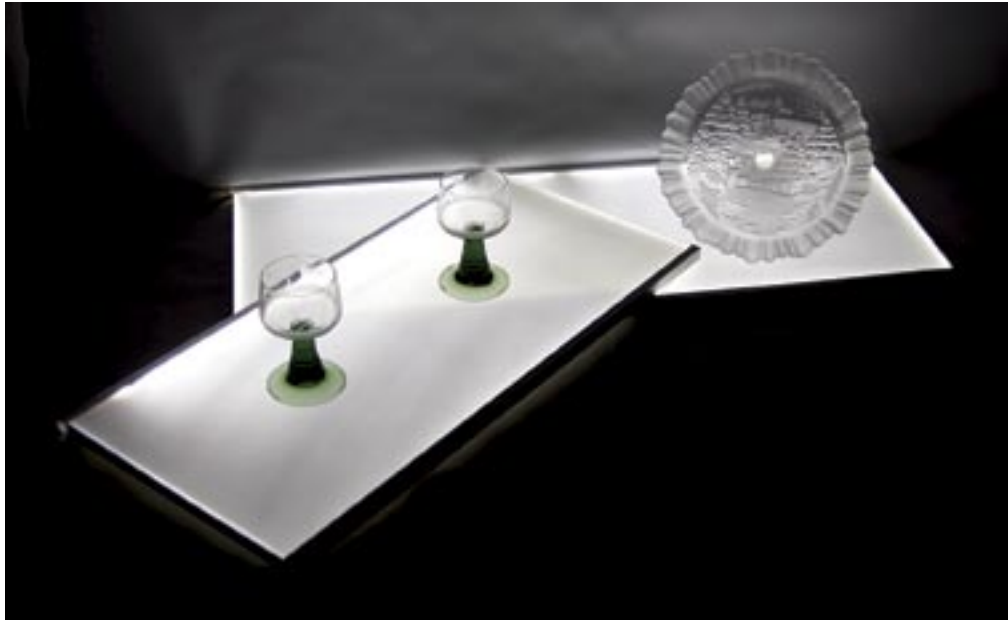

Height: $\frac{3}{8}$ " , Depth: 10 $\frac{1}{2}$ "
 Lengths: 16 $\frac{1}{2}$ " , 22 $\frac{1}{2}$ " and 28 $\frac{1}{2}$ "

- Bright, white light evenly distributed over entire shelf
- Very little heat, safe to use even in enclosed cabinets
- Includes Cold Cathode light bulb(s) – 12,000 hours (average life)
- Economical, low energy consumption (3 watts per foot)
- Link multiple units together (up to 4)
- Single-side illumination
- Available in warm white 3200°K and cool white 6500°K
- Power supply sold separately

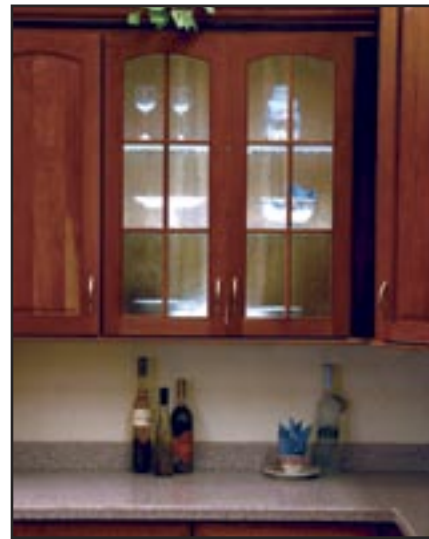

Illumishelf used in tinted glass application.

Item #	Description
CCSL-18-CW	16 $\frac{1}{2}$ " Illumishelf 5 watts
CCSL-18-WW	includes inverter and "Y" connector
CCSL-24-CW	22 $\frac{1}{2}$ " Illumishelf 6 watts
CCSL-24-WW	includes inverter and "Y" connector
CCSL-30-CW	28 $\frac{1}{2}$ " Illumishelf 8 watts
CCSL-30-WW	includes inverter and "Y" connector
CC-PS3	36 watt 3 amp plug-in power supply, 12V DC
CC-PS5	60 watt 5 amp plug-in power supply, 12V DC

The Illumishelf fits standard 18", 24" and 30" kitchen cabinets. Custom sizes are also available. Please call for assistance.

Clear Channel

Adjustable bright energy efficient light in a sleek Clear Channel.



Height: 1/2", Width: 1/2", Lengths: 13 3/4", 20 3/4" and 27 3/4"

- Bright, warm white linear light
- Minimal heat generated for maximum safety
- Includes Cold Cathode light bulb – 12,000 hours (average life)
- Low profile, 1/2" clear polycarbonate tube
- Remote ballast and transformer allow for simple installation
- Energy efficient cold cathode lamp uses 4 watts per foot
- Rotates 180°–swivel mounting hardware included
- Can be used in a variety of cabinet applications
- 12V power supply sold separately

Item #	Description
CC-14	13 3/4" Clear Channel, 3 watts Includes inverter, "Y" connector and 3200°K lamp
CC-21	20 1/4" Clear Channel, 5 watts Includes inverter, "Y" connector and 3200°K lamp
CC-28	27 3/8" Clear Channel, 7 watts Includes inverter, "Y" connector and 3200°K lamp
CC-PS3	36 watt 3 amp plug-in power supply, 12VDC
CC-PS5	60 watt 5 amp plug-in power supply, 12VDC

Can be used for curio cabinets, stereo cabinets, bookcases, etc.



Brite-Line

A powerful, miniature light that will work end-to-end for a continuous band of light!



Height: 3/8", Width: 3/8", Lengths: 9 3/8", 17 3/8" and 25 3/8"

- Bright, cool white linear light
- Low profile, 3/8" square aluminum "U" channel
- Minimal heat generated for maximum safety
- Remote ballast and transformer allow for simple installation
- Energy efficient cold cathode lamp uses 4 watts per foot
- Includes Cold Cathode light bulb – 12,000 hours (average life)
- Install end-to-end for continuous light
- Double-sided tape included
- 12V power supply sold separately

Item #	Description
BRL-8-CH	9 3/8" Brite-Line, 3 watts
BRL-8-WH	Includes inverter, "Y" connector and 6500°K lamp
BRL-8-BR	
BRL-16-CH	17 3/8" Brite-Line, 5 watts
BRL-16-WH	Includes inverter, "Y" connector and 6500°K lamp
BRL-16-BR	
BRL-24-CH	24 3/8" Brite-Line, 7 watts
BRL-24-WH	Includes inverter, "Y" connector and 6500°K lamp
BRL-24-BR	
CC-PS3	36 watt 3 amp plug-in power supply, 12VDC
CC-PS5	60 watt 5 amp plug-in power supply, 12VDC

Color: Chrome (CH), White (WH) and Bronze (BR). Custom sizes are also available. Please call for assistance.



Xenon 120V Under Cabinet Light

New! Cooler than Halogen, brighter than Fluorescent and easy to install.



Height: 1 1/4", Depth: 4 1/2"
Lengths: 8", 16", 24" and 32" 

- Bright white light – ideal for countertops and workstations
- Includes 120V Xenon light bulbs – 8,000 hours (average life)
- Dimmable
- Low profile, only 1 1/4" high
- Frosted lens allows for even light distribution
- Convenient Hi/Low switch
- Hinged lens makes lamp replacement safe and easy
- Link portable fixtures with optional 12" or 24" extension
- Direct wire box available (see accessories below)

Patent Pending



Item #	Hardwire Description
LXC1H-WH	Xenon Under Cabinet Fixture
LXC1H-BS	120V, 20 watts, 8" Length, 1-Light
LXC1H-BR	Hardwire
LXC2H-WH	Xenon Under Cabinet Fixture
LXC2H-BS	120V, 40 watts, 16" Length, 2-Light
LXC2H-BR	Hardwire
LXC3H-WH	Xenon Under Cabinet Fixture
LXC3H-BS	120V, 60 watts, 24" Length, 3-Light
LXC3H-BR	Hardwire
LXC4H-WH	Xenon Under Cabinet Fixture
LXC4H-BS	120V, 80 watts, 32" Length, 4-Light
LXC4H-BR	Hardwire

Item #	Portable Description
LXC1P-WH	Xenon Under Cabinet Fixture
LXC1P-BS	120V, 20 watts, 8" Length, 1-Light
LXC1P-BR	Plug-in
LXC2P-WH	Xenon Under Cabinet Fixture
LXC2P-BS	120V, 40 watts, 16" Length, 2-Light
LXC2P-BR	Plug-in
LXC3P-WH	Xenon Under Cabinet Fixture
LXC3P-BS	120V, 60 watts, 24" Length, 3-Light
LXC3P-BR	Plug-in
LXC4P-WH	Xenon Under Cabinet Fixture
LXC4P-BS	120V, 80 watts, 32" Length, 4-Light
LXC4P-BR	Plug-in
LXCP-20BP	120V Xenon replacement bulb, 20 watts

Colors: Brushed Steel (BS) and Bronze (BR) with 6 foot black cord.
White (WH) with 6 foot white cord.



Halogen 120V Under Cabinet Light

Contemporary styling and bright white light.

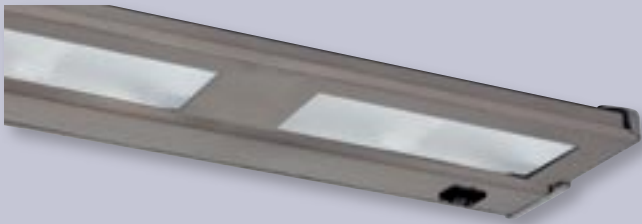

Patent Pending

Height: 1 1/4", Depth: 4 1/2"
Lengths: 8", 16", 24" and 32" 

- Includes 120V Halogen light bulb(s) – 2,500 hours (average life)
- Dimmable
- Low-profile, only 1 1/4" high
- Contemporary style in three great finishes
- Convenient Hi/Low switch
- Frosted lens softens and diffuses light
- Hinged lens cover for easy lamp replacement
- Link portable fixtures with optional 12" or 24" extensions
- Direct wire box available (see accessories below)

Item #	Hardwire Description
LHC1H-WH	Halogen Under Cabinet Fixture
LHC1H-BS	120V, 35 watts, 8" Length, 1-Light
LHC1H-BR	Hardwire
LHC2H-WH	Halogen Under Cabinet Fixture
LHC2H-BS	120V, 70 watts, 16" Length, 2-Light
LHC2H-BR	Hardwire
LHC3H-WH	Halogen Under Cabinet Fixture
LHC3H-BS	120V, 105 watts, 24" Length, 3-Light
LHC3H-BR	Hardwire
LHC4H-WH	Halogen Under Cabinet Fixture
LHC4H-BS	120V, 140 watts, 32" Length, 4-Light
LHC4H-BR	Hardwire

Item #	Portable Description
LHC1P-WH	Halogen Under Cabinet Fixture 120V, 35 watts, 8" Length, 1-Light Plug-in
LHC2P-WH	Halogen Under Cabinet Fixture 120V, 70 watts, 16" Length, 2-Light Plug-in
LHC3P-WH	Halogen Under Cabinet Fixture 120V, 105 watts, 24" Length, 3-Light Plug-in
LHC35B-BP	120V Halogen replacement bulb, 35 watts

Colors: Brushed Steel (BS) and Bronze (BR) with 6 foot black cord. White (WH) with 6 foot white cord.



Xenon 120V Puck Light

Bright white light without the need for a transformer.



Surface mount height: 1 3/8" 
Recess mount height: 1/2", Diameter: 2 5/8"

- Versatile, no transformer needed
- Does not emit damaging ultraviolet (UV) rays
- Dimmable
- Includes 120V Xenon light bulb(s) – 8,000 hours (average life)
- Lasts three times longer than Halogen
- Frosted twist lock lens reduces glare
- Twist-off lens cover makes lamp replacement easy
- Ventilation pins provide airflow between puck light and mounting surface
- Can be used in a variety of cabinet applications
- Link up to ten units together
- Direct wire box available (see accessories below)

Item #	Description
LVPX20WH-B	Xenon 120V Puck Light - Boxed
LVPX20BK-B	Includes (1) 20 watt Xenon bulb
LVPX20CH-B	Power cord not included
LVPX20GD-B	Requires ALLVPPC6
LVPX20WH	Xenon 120V Puck Light - Blister Pack
LVPX20BK	Includes 6 foot power cord with
LVPX20CH	slide-on plug and (1) 20 watt Xenon
LVPX20GD	bulb
LVPX40WH	Xenon 120V Two Puck Kit - Blister Pack
LVPX40BK	Includes 6 foot power cord with
LVPX40CH	slide-on plug, (1) 12" extension and
LVPX40GD	(2) 20 watt Xenon bulbs
LVPX80WH	Xenon 120V Four Puck Kit - Blister Pack
LVPX80BK	Includes 6 foot power cord with
LVPX80CH	slide-on plug, (3) 12" extensions and
LVPX80GD	(4) 20 watt Xenon bulbs
ALLVPPC6-B	6 foot power cord – Boxed
ALLVPPC6WH-B	With slide-on plug and roll switch Black or White
ALLVPPC6	6 foot power cord – Blister Pack
ALLVPPC6WH	With slide-on plug and roll switch Black or White
LVPX20B	120V Xenon replacement bulb, 20 watts, two per Blister Pack

Colors: Chrome (CH), Gold (GD) and Black (BK) with 6 foot black cord. White (WH) with 6 foot white cord.



Halogen 120V Puck Light

Halogen lighting without the need for a transformer.



Surface mount height: 1 3/8" 
 Recess mount height: 1/2", Diameter: 2 5/8"

- Easy to install – just plug them in!
- Dimmable
- Includes 120V Halogen light bulb – 2,500 hours (average life)
- Frosted twist-lock lens reduces glare
- Ventilation pins provide airflow between puck light and mounting surface
- Can be used in a variety of cabinet applications
- Link up to ten units together
- Direct wire boxes available (see accessories below)

Item #	Description
ALLVP20WH-B	120V Halogen Puck Light - Boxed
ALLVP20BK-B	Includes (1) 20 watt Halogen bulb
ALLVP20CH-B	Power cord not included
ALLVP20GD-B	Requires ALLVPPC6
ALLVP20WH	120V Halogen Puck Light - Blister Pack
ALLVP20BK	Includes 6 foot power cord with
ALLVP20CH	slide-on plug and (1) 20 watt
ALLVP20GD	Halogen bulb
ALLVPTDIM	Touch pad dimmer, 120V
ALLVPPC6-B	6 foot power cord – Boxed
ALLVPPC6WH-B	With slide-on plug and roll switch Black or White
ALLVPPC6	6 foot power cord – Blister Pack
ALLVPPC6WH	With slide-on plug and roll switch Black or White
ALLVP20B	120V Halogen replacement bulb 20 watts, two per Blister Pack

Colors: Chrome (CH), Gold (GD) and Black (BK) with 6 foot black cord. White (WH) with 6 foot white cord.



Xenon 12V Puck Light

Cooler than Halogen and longer lamp life makes this a perfect solution.



Surface mount height: 1 3/8" 
 Recess mount height: 1/2", Diameter: 2 5/8"

- Does not emit damaging ultraviolet (UV) rays
- Dimmable
- Includes 12V Xenon light bulb(s) – 10,000 hours (average life)
- Lasts four times longer than Halogen
- 48" Lead wire with screw-down terminal block
- Frosted, glare-free, twist-lock lens
- Ventilation pins provide airflow between puck light and mounting surface
- Can be used in a variety of cabinet applications

Item #	Description
ALPX20WH-B	Xenon Puck Light – Boxed
ALPX20BK-B	Includes (1) 20 watt, 12V Xenon bulb
ALPX20GD-B	
ALPX20CH-B	
ALPX20WH	Xenon Puck Light – Blister Pack
ALPX20BK	Includes (1) 20 watt, 12V Xenon bulb
ALPX20GD	
ALPX20CH	
ALPX40WH	Xenon 2-Puck Light Kit – Blister Pack
ALPX40BK	Includes 2 puck lights, (2) 20 watt, 12V
ALPX40GD	Xenon bulbs and 60 watt transformer
ALPX40CH	
ALPX60WH	Xenon 3-Puck Light Kit – Blister Pack
ALPX60BK	Includes 3 puck lights, (3) 20 watt, 12V
ALPX60GD	Xenon bulbs and 60 watt transformer
ALPX60CH	
ALX10BX	12V Xenon replacement bulbs 10 watts, two per Blister Pack
ALX20BP	12V Xenon replacement bulbs 20 watts, two per Blister Pack

Colors: Chrome (CH), Gold (GD) and Black (BK) with black lead wire. White (WH) with white lead wire. Transformer sold separately.

*See pages 27-28 for appropriate transformers.



Halogen 12V Puck Light

Halogen Puck Lights are an excellent choice when a small, powerful light is required.



Surface mount height: 1 3/8" 
 Recess mount height: 1/2", Diameter: 2 5/8"

- Dimmable
- Includes 12V Halogen light bulb – 2,500 hours (average life)
- 48" Lead wire with screw down terminal block
- Frosted, glare-free, twist-lock lens
- Ventilation pins provide airflow between puck light and mounting surface
- Can be used in a variety of cabinet applications

Item #	Description
ALP20WH-B	Halogen Puck Light – Boxed Only
ALP20BK-B	Includes (1) 20 watt, 12V Halogen bulb
ALP20GD-B	
ALTPDIM	3-Level Touch Dimmer, 300 watts
AL20B	12V Halogen replacement bulb, 20 watts One per Blister Pack

Colors: Gold (GD) and Black (BK) with black lead wire. White (WH) with white lead wire. Transformer sold separately.
 *See pages 27-28 for appropriate transformers.



Illuminated Counter Top Displays are available for all Under Cabinet Products. Choose one with any \$500.00 purchase.



Fluorescent Task Light

New, versatile, and energy efficient. Just plug-in!



Surface mount height: 1 1/4" 
 Recess mount height: 5/16", Width: 2 9/16", Length: 6 7/8"

- Energy efficient – only 4 watts!
- Low profile fixture fits in tight spaces
- Includes 120V T5 Fluorescent light bulb – 8,000 hours (average life)
- Link up to ten units together
- Prismatic, glare-free lens
- Can be used in a variety of cabinet applications

Item #	Description
ALFLP20WH	Fluorescent Puck Light—Retail Pack
ALFLP20BK	Includes 6 foot power cord with
ALFLP20CH	slide-on plug, roll switch and 4 watt T5
ALFLP20GD	Fluorescent bulb

Colors: Chrome (CH), Gold (GD) and Black (BK) with 6 foot black cord. White (WH) with 6 foot white cord.



Ultra-Thin Fluorescent Light

Energy efficient, cool burning light in a very slim package.

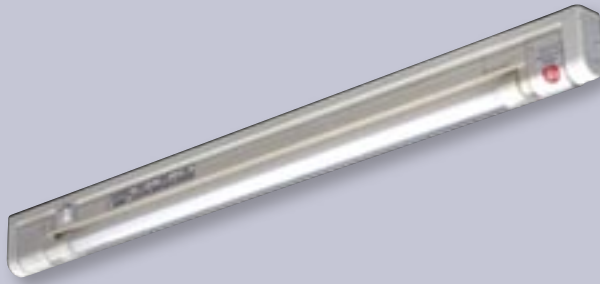

Height: 1 1/4", Width: 5/8" 
Lengths: 15" and 21"

- Brighter workspace lighting from a smaller fixture
- Tri-Phosphor coating provides warm light (3100°K)
- Touch On/Off switch with LED indicator
- Instant "On"
- Includes T4 Fluorescent light bulb – 10,000 hours (average life)
- Link up to ten units together with in-line connector (included) or linkable connectors (see below)
- Durable lens cover protects light bulb
- Electronic ballast eliminates flicker and hum
- Direct wire box available (see accessories below)
- 6' power cord included

Item #	Description
ALFLT415	Ultra-Thin Fluorescent Light
ALFLT421	15" fixture, 8 watts or 21" fixture, 16 watts, White, Blister Pack
ALLVPEX12	12" and 24" Extension cables
ALLVPEX24	link up to ten lights together
ALHWBOX	Direct Wire Box, (2) 120V outlets & (2) on/off switches
ALFL8B	Tri-Phosphor T4 replacement bulb
ALFL16B	8 watts and 16 watts

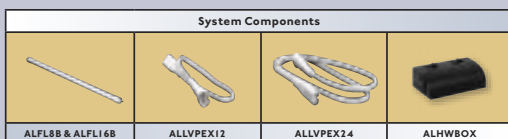

Adjustable Fluorescent Light

Direct the light exactly where you need it!



Height: 1 1/4", Depth: 4 1/2" 
Lengths: 15" and 21"

- Fixture rotates 180°
- Tri-Phosphor coating provides warm, white light
- Includes T4 Fluorescent light bulb – 10,000 hours (average life)
- Link up to ten units together, 6" extension included
- Mirrored reflector housing efficiently distributes light
- Convenient On/Off switch
- Optional 12"/24" extensions and direct wire boxes available (see accessories below)
- Electronic ballast eliminates flicker and hum
- Instant "On"
- 6' power cord included

Item #	Description
ALFLSW815	Adjustable Fluorescent Light
ALFLSW1621	8 watt, 15" fixture, white or 16 watt, 21" fixture, white
ALLVPEX12WH	Linkable Connector – use like an extension cord, 12" or 24", White
ALLVPEX24WH	Linkable Connector – use like an extension cord, 12" or 24", White
ALFL8B	Tri-Phosphor T4 replacement bulb
ALFL16B	8 watts or 16 watts

ADJUSTABLE • FLUORESCENT LIGHT

Features

- Switches 180°
- Bright, white light
- Energy efficient T4 Fluorescent
- Link up to 10 units
- Durable steel housing
- Convenient On/Off Switch
- 6' power cord

Applications

- Under cabinets
- Desks
- Entertainment centers
- Bookshelves
- Garage work areas

Volts • 120v
Bulb Life • 8,000 Hrs
Output • 8 or 16 Watts
Included • Mounting Hardware



Illuminated Retail Displays are available for all Under Cabinet Products. Display includes 2 foot by 5 foot black grid with mounting base and display hooks. Available with any purchase of \$750.00 or more.



Linear Lighting Systems



Linear Accent Series

Flexible, low voltage, versatile system with limitless applications!



Lamp holder with bulb stands 1" high

- Pre-assembled lamp holders on 12 gauge SPT-2 cable
- 3", 4" and 6" spacing (on-center) for maximum flexibility
- Mounting track available for straight-line installations
- Easily convert to spotlight with socket adapter for MR11 and MR16 bulbs, 20 watts max
- 100 foot spools are available and can be cut to length
- Lamp holders feature a built in reflector for maximum light output
- Dimmable, 12V and 24V
- Perfect for coves, soffits, under cabinets, work stations and accent lighting applications

Item #	Description
FSL-3	Pre-assembled Linear Accent Series
FSL-4	3", 4" and 6" spacing on-center available
FSL-6	Custom cut or 100 foot spools
FSL-TRK-3	3 foot White mounting track
FSL-TRK-4	4 foot White mounting track
FSL-END	End Cap, White
FSL-BLK	Connector Block, 2-wire, 12-gauge
FSL-BOX	Junction box for FSL-BLK
FSL-SOCKET	Replacement Socket
FSL-CLIP	Saddle mounting clip
FSL-COVER	Lens Cover, use with 5 watt bulb only
FSL-CABLE	Replacement Cable, 12-gauge, White
FSL-5-12/24	5 watts, 12V or 24V bulb, Clear
FSL-10-12/24	10 watts, 12V or 24V bulb, Clear
FSL-5F-12/24	5 watts, 12V or 24V bulb, Frosted
FSL-10F-12/24	10 watts, 12V or 24V bulb, Frosted
MR-II/16A*	Swivel Socket attachment for MR II's
MR-II-12*	MR II Bulb for Linear Accent Series
MR-II-24*	12V or 24V, 20 watts

* MR II lamps are sold separately and require MR-II/16A adapters.



Linear Accent Kits

Item #	Description
FSLK-2	2 foot kit 4" o/c with 60 watt transformer
FSLK-4	4 foot kit 4" o/c with 80 watt transformer
FSLK-6	6 foot kit 4" o/c with 105 watt transformer
FSLK-10	10 foot kit 4" o/c with 150 watt transformer
FSL-TRK-3	3' White mounting track
FSLK-BU	(2) 5 watt 12V Xenon lamps Blister Pack
FSLK-EX	Extension Kit - 36" with two connector blocks - Blister Pack
FSLK-CV	Clear Lens Covers-six per Blister Pack

All kits include 5 watt bulbs on 12 gauge wire, 4" spacing on-center (o/c), a transformer and mounting accessories. 12V Xenon bulbs have an average life of 20,000 hours.



Maximum Single Run Distance

5 watt 10 watt	Maximum Single Run Distance		
	3"	4"	6"
12V	12'	16'	24'
24V	24'	32'	48'

240 watts maximum for 12V run. 480 watts maximum for 24V run.

*See pages 27-28 for appropriate transformers.

X-Cove Light

Versatile, elegant accent lighting.



Socket dimensions: 1/2" Length x 2/3" Height 

- Low profile design – socket with bulb stands 1 1/4" tall
- Pre-assembled lamp holders on 14 gauge SPT-2 Wire
- 4" lamp spacing on-center
- 330 foot spools are available and can be cut to length
- Use either Incandescent or Xenon bulbs
- Maximum run for 24V is 300 watts and for 12V is 150 watts

Item #	Description
X-COVE	X-Cove Light 4" spacing
X-CLIP	Mounting Clips
X-END	End Cap
FSL-BLK	Connector Block
FSL-BOX	Junction Box for FSL-BLK
FSL-WIRE	Lead Wire, 12 gauge SPT-2, White
C-CAP-COLOR	Plastic Cap - Clear, Red, Green, Blue, Yellow. Cap can be only used with 3 watt lamp
BX-5-12	12V Xenon bulb, 5 watts
BX-5-24	24V Xenon bulb, 5 watts 11,000 hours (average life)
BC-3-12	12V Incandescent Bulb, 3 watts
BC-3-24	24V Incandescent Bulb, 3 watts 2,000 hours (average life)

*See pages 27-28 for appropriate transformers.



Tape Light

Flexible, low voltage system great for highlighting architectural elements.



Width: 1/2", Height: 3/4" with bulb 

- Includes 24V Incandescent light bulb(s) – 20,000 hours (average life)
- Parallel wiring – if one bulb burns out, the rest stay lit
- 2", 3" and 4" on center spacing available
- Field cuttable for maximum flexibility
- Lightweight – easy to attach
- For indoor use only
- Maximum Run Distance 200 bulbs: 2" - 33 feet; 3" - 50 feet; 4" - 66 feet

Item #	Description
TL-2-2	Tape Light, 2 wire
TL-2-3	2", 3" and 4" on center
TL-2-4	24V, Clear tape and socket
TL-BULB-24	Replacement bulb, 24V, .96 watts 40ma
TL-CAP-I	Colored Caps; Red, Green, Blue,
TL-CAP-O	Yellow, Clear; Indoor and Outdoor
TL-CL-I	Bulb Mounting clip
TL-RR	Tape Light retainer ring
TL-END	End Cap, Clear
TL-CONBL2	Connector Block

Bulb Specifications: 24V, .96 watt, 40ma
Maximum Run: 200 Bulbs

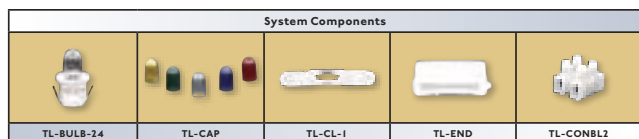

Rope Light

Flexible, versatile, long-lasting, colorful, dimmable and easy to use.



- Colors: Clear, Frosted, Red, Green, Blue, Yellow, Amber, Purple and Pink 
- Available in bulk reels, kits and custom cut to size
- 25,000 hours (average life)
- Crushproof to 240 PSI
- Field cuttable: 12V - 2"; 24V - 4"; 120V - 18"
- Maximum Run Distance: 120V - 150 feet; 12V - 16 feet; 24V - 32 feet
- Energy consumption: 5.5 watts per foot
- 3/8" and 1/2" diameter sizes available
- Dimmable

Item #	Description
DL/MDL-COLOR	Bulk Rope Light*
DL/MDL-CONKIT-6	Bulk Connector Kit
DL/MDL-PWR	Power Connector
DL/MDL-END	End Cap
DL/MDL-SPL	Splice Connector
DL/MDL-EXT-2-KIT	2 foot Extension Kit
DL/MDL-CLIP	"U" shaped mounting clip
DL/MDL-TRACK-4	4 foot Clear mounting track

*DL = 1/2" Rope Light, MDL = 3/8" Rope Light, 150' reels
 Bulb Specifications: 1" spacing, 6.5V, .5 watts, 70MA
 Rope Light is available in 12V, 24V and 120V. Power cords are available in lengths of 2 feet, 6 feet and 15 feet.

Rope Light Kits

Item #	Description
LR-CL-6	Rope Light Kits - 1/2" in diameter
LR-CL-9	Includes power cord,
LR-CL-15	connector kit and mounting
LR-CL-30	accessories. 6 feet, 9 feet, 15 feet,
LR-CL-45	30 feet and 45 feet lengths available

*Rope Light Kits are available in clear only.

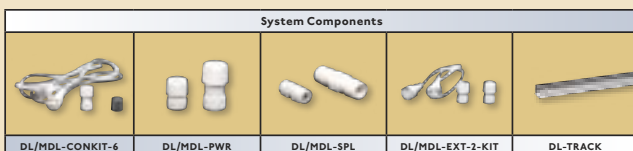

Chasing Rope Light

Bright, colorful and attention grabbing! Nothing catches your eye like moving lights.



- Colors: Clear, Frosted, Red, Green, Blue, Yellow, Amber, Purple and Pink 
- Bi-Colors: Red/Clear, Red/Yellow, Red/Green, Yellow/Green
- 25,000 hours (average life)
- Crushproof to 240 PSI
- Maximum run distance: 150 feet
- Energy consumption: 5.5 watts per foot
- Field cuttable every 36" for maximum flexibility
- 1/2" diameter

Item #	Description
DLCH-COLOR	Bulk Chasing Rope Light*
DLCH-PC6	Bulk 5 feet power cord for "all-on"
DLCH-PWR	Power Connector
DL-END	End Cap
DLCH-SPL	Splice Connector
DLCH-T	"T" Connector to combine three sections
DLCH-Y	"Y" connector with power cord to power two runs of rope light
DLCH-EX	10 foot extension to link two sections
DLCH-EC	10 foot extension, rope to controller
DLCH-30	Controller, chases up to 30 feet of rope
DLCH-202	Controller, chases up to 150 feet of rope
DL-CLIP	"U" shaped mounting clip
DL-COND	"P" shaped conduit clip
DL-TRACK-4	4 foot Clear mounting track

*Bulb specifications: 1" spacing, 6.5V, .5 watts, 70ma.

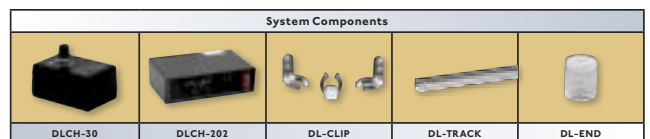

Crystal Tube Light

A low profile light that provides safety and style for all types of floor surfaces.



ST-1003 Tube Height: 1/4", **Width:** 5/16"

- Perfect for steps, aisles, pathways or enhancing architectural detail
- Tube colors: Clear, Red, Green, Blue, Amber and Smoke
- 40,000 hours (average life)
- Premium quality bulbs wired in series, 12V or 24V
- Tube length: Clear 24 feet, all other colors 20 feet
- Maximum run distance: 120 lamps for 24V and 72 lamps for 12V
- Bulb specifications: .5 watts, 70ma
- Bulb spacings: 1", 2", 3", 4", 6" and 12"
- Rated for indoor & outdoor use

Item #	Description
ST-1003	1/4" x 5/16" polycarbonate tube with custom lamp spacing
STMC-1	"U" Clip for 1003
STBP-1	Bi-pin in-line connector
STBP-2	Bi-pin corner connector
CE-BRONZE	Carpet to Edge Extrusion
CE-NATURAL	Use to abut a wall or a step riser
CF-BRONZE	Carpet to Floor Extrusion
CF-NATURAL	Helps indicate change in floor surface
CS-BRONZE	Carpeted Step Extrusion – Adds a safety factor and prevents wear at the bullnose
CS-NATURAL	
BS-BRONZE	Bare Step Extrusion – For installations on wood, tile or concrete
BS-NATURAL	
PU-EXTRUSION	Clear Polycarbonate "U" Channel
PT/PC-EXTRUSION	PVC channel with a removable cap for concrete application

*See pages 27-28 for appropriate transformers.

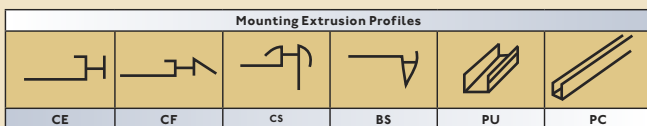

Clip Light

A safe low voltage alternative source for year round tree lighting and building outlines



Dimensions: 1/2" Length x 5/8" Width x 7/8" Height w/lamp 

- Sockets mounted on 18 gauge wire rated for outdoor use
- Includes 12V or 24V incandescent bulb(s) – 20,000 hours (average life)
- Parallel wiring if one bulb burns out the rest stay lit
- Field cuttable
- Dark green wire and socket

Item #	Description
CL-2-GR-12/24	Clip Light, 12V and 24V 18 gauge wire.
CL-6-GR-12/24	Bulb spacing: 2", 6", 9" and 12" on-center
CL-9-GR-12/24	Dark green wire and socket
CL-12-GR-12/24	
CL-SOCK-COLOR	Socket Bulb: Clear, Green, Black
CL-WIRE-COLOR	18 gauge stranded wire Black, Green and White
CL-BULB-12/24	Replacement bulbs, 12V/.5 watt and 24V/1 watt
CL-RR	Retainer ring for through-mounting
CL-CAP-I	Colored Caps: Red, Green, Blue
CL-CAP-O	Yellow and Clear; Indoor and Outdoor use

Wattage: 12V bulbs use .5 watt each and 24V use .96 watt each.
Maximum Run: 80 bulbs for 12V; 175 bulbs for 24V.

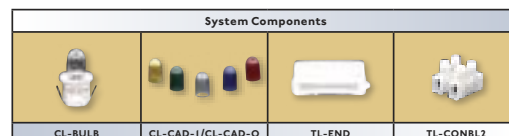

Festoon Light String

Low maintenance lighting system designed for installations where lamp changing is difficult.

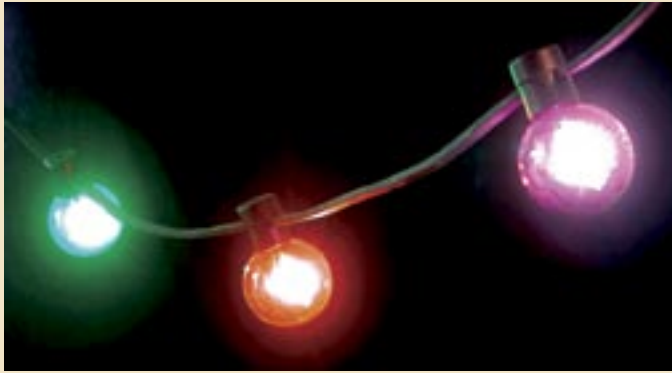

Diameter: 2 1/2" Polycarbonate Globes 

- Custom manufactured to your exact specifications
- A complete system includes cable, sockets, bulbs, and globes
- Safe, multipurpose energy saving system
- Clear or colored polycarbonate globes available
- Waterproof and resistant to vibration
- Parallel wiring means loss of one bulb does not affect remaining bulbs
- Ideal for buildings, bridges and other structures
- Halogen 3,000 hours (average life) or Xenon 20,000 hours (average life)

Item #	Description
LFS-I2-5	Festoon Light Socket with Globe and 12V Halogen bulb, 5 watts 12 gauge wire sold separately*
LFS-24-5	Festoon Light Socket with Globe and 24V Xenon bulb, 5 watts, 8.5 watts or 10 watts
LFS-24-8.5	
LFS-24-10	12 gauge wire sold separately*
LFS-CABLE	Festoon Light String Cable, 12 gauge
LFS-CC	Cable Clip with nail, Black
LFS-BP	Mounting Backplate attached to socket for steel guide wire
LFS-I2-5 B	12V Halogen bulb, 5 watts
LFS-24-5/8.5/10 B	24V Xenon bulb, 5 watts, 8.5 watts or 10 watts
LFS-GLOBE	2 1/2" Shatterproof Globe Specify Clear, Blue, Green, Red, Yellow, Pink or Purple

12V maximum run is 300 watts; 24V maximum run is 600 watts; Sockets and cable are Black. See pages 27-28 for appropriate transformers.

*When ordering, please specify linear feet of light socket cable, number of light sockets needed, and spacing on-center. Each order is assembled per customer specifications before it is shipped.

Festival Lights

Durable low voltage light strings give a festive look to any application.



Diameters: 1 1/2" and 3" Polycarbonate Globes

- Clear or colored polycarbonate globes provide a secure watertight seal around bulb
- Sockets firmly attached to 12 gauge wire
- Bulb spacings: 6", 12", 18" and 24"
- Parallel wiring means loss of one bulb does not affect remaining bulbs
- 330 foot bulk reels are available or specify custom length
- Field cuttable for custom applications
- Socket base features holes for surface mounting

Item #	Description
FL-6	Festival Lights, 24V
FL-I2	Spacing: 6", 12", 18" and 24" available
FL-I8	Bulbs and globes sold separately
FL-24	
FL-BULB-5W	24V Festival Bulb, E-10 base, 5 watts 15,000 hours (average life)
FL-I.5-COLOR	Polycarbonate Globe, diameter: 1 1/2" Clear, Blue, Green, Red, Yellow, White
FL-3-COLOR	Polycarbonate Globe, diameter: 3" Clear, Blue, Green, Red, Yellow, White

* Maximum run is 96 bulbs or 480 watts

* See pages 27-28 for appropriate transformers.

Light Strings (Commercial Grade)

The perfect solution for festive outdoor lighting!



- Great for lighting restaurant interiors, building outlines, patio lighting, gazebos, and many other applications
- Available in your choice of colors, sockets sizes and socket spacings (see below for details)
- PVC socket forms a tight weatherproof seal around the bulb
- Maximum 25 watts per socket (see page 32 for Long Life Bulbs)
- 330 foot Bulk Reels are available or specify custom length
- Field cuttable for custom applications
- 1,400 watts maximum for 330 foot reels
- For indoor and outdoor use
- 16 gauge wire

Item #	Description
LS-C-12	Candelabra Base Light String Sockets 12" on-center, plug sold separately Black, White or Green wire
LS-I-15	Intermediate Base Light String Sockets 15" on-center, plug sold separately Black, White or Green wire
LS-M-24	Medium Base Light String Sockets 24" on-center, plug sold separately Black or Green wire
LS-MS-24	Medium Base Light String with suspended sockets, 24" on-center, plug sold separately, Black or Green wire
LS-M-24-48	48 foot Medium Base Light String Sockets 24" on-center, with plug Black or Green wire
LS-MS-24-48	48 foot Medium Base Light String with suspended sockets, 24" on-center, with plug, Black or Green wire
X-END	Silicone End Cap, Clear
LS-PLUG	Quick Plug, 2-blade, Black, for indoor use
LS-I-15-100-WH	Intermediate base light string with plug White wire while supplies last Maximum of 700 watts, 15" spacing

Long life bulbs sold separately. See page 33.

Belt Light

Chasing marquee lighting has never been so easy to create!



Socket Height: 1³/₈", Diameter: 1³/₈"

- Use with controller for eye catching chasing effects or hardwire for "all-on" applications
- Flexible 5-wire PVC belt with 4" or 6" on-center socket spacing
- Surface mount or insert sockets through 1¹/₄" holes
- Field cuttable for maximum flexibility
- For indoor use only
- Grey cable and socket

Item #	Description
BL-4	Custom Cut Belt Light
BL-6	4" and 6" socket spacing, medium base 200 feet per roll, 15 amp maximum*
BL-20-60	Belt Light, 4" socket spacing, medium base*
BL-40-120	20 foot length has 60 sockets and 40 foot length has 120 sockets
BL-20-40	Belt Light, 6" Socket spacing, medium base*
BL-40-80	20 foot length has 40 sockets and 40 foot length has 80 sockets
BLC 105	Belt Light Controller, 5 chasing patterns, 840 watts maximum
RLC-737	Belt Light Controller 4 patterns plus "all-on" 1600 watts maximum
BL-END-CL	End Cap
BL-CLIP-CL	Mounting Clip

*"All-on" run is 650 watts maximum and chasing run is 840 watts maximum per channel. Use 25 watt bulbs maximum. Long Life Bulbs sold separately. See page 32.

Fiber Optic Lighting

A flexible, versatile alternative to neon and other traditional electric lighting products.



- Ideal for signs, star ceilings, building outlines, cove lighting, architectural details, fountains and swimming pools
- Multiple fiber types available for maximum versatility
- Safe – no electricity in the cable itself
- Cool – emits little or no heat
- Use a color wheel for color-changing effects
- Synchronize multiple metal halide units with a synchronous controller



Fiber Optic Illuminators

	Description
FOI-150-MH-C	Metal Halide Illuminator with color wheel and 150 watt lamp Dimensions: 12" x 11" x 6"
FOI-150MH	Replacement lamp for FOI-150-MH-C 6,000 hours (average life)
FOG-150Q	Quartz Halogen Illuminator with color wheel and 150 watt lamp Dimensions: 7" x 6.5" x 5"
FOB-150Q	Replacement Lamp for FOG-150Q 1,500 hours (average life)
FOC-50-150Q FOC-100-150Q FOC-200-150Q	Fiber Connector for FOG-150Q Holds 50, 100 or 200 fibers

Side Emitting Fiber Cable

Fiber Cable	Description
FIB-50 FIB-100	Stranded Fiber Cable. 3/8" cable with 42 strand and FIB-50. 1/2" cable with 84 strand FIB-100; cluster of .75mm fibers in clear PVC jacket
FIBS-250 FIBS-375 FIBS-500	Solid Fiber Cable, 1/4", 3/8" and 1/2" diameter size in clear PVC jacket
DL-TRACK-4 MDL-TRACK-4	"U" Shaped mounting track 4 foot sections, 3/8" and 1/2" size
FO-KNIFE-L FO-KNIFE-H	Hot knife cuts stranded fiber cable Light and heavy-duty capability

End Emitting

Fiber Cable	Description
FSK-300 FSK-300 (long)	Fiber Optic Star Kit, 300 fibers* 8-12 foot and 16-20 foot fiber lengths
FOG-75C	Quartz Halogen Star Illuminator with twinkle wheel and 75 watt lamp, Dimensions: 7" x 6.5" x 5"
FOC-100-75C FOC-200-75C FOC-500-75C	Fiber Connector for FOG-75C Holds 100, 200 or 500 fibers
FSK-CWHEEL	Color Wheel, plastic Colors: Clear, Purple, Yellow, Blue, Green and Red
FS.75 FS 1.0 FS 1.5 FS2.0	.75mm End Emitting Fiber 8856' per spool 1.0mm End Emitting Fiber 4920' per spool 1.5mm End Emitting Fiber 2460' per spool 2.0mm End Emitting Fiber 820' per spool Sold as full spools only

* 70% of fibers are .75mm, 20% of fibers are 1.0mm, 10% of fibers are 1.5mm

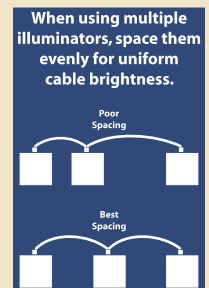
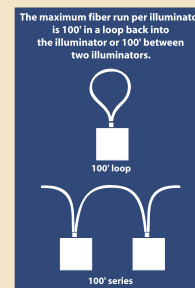
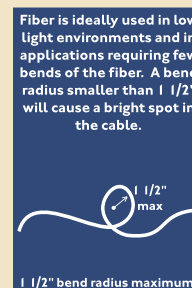

LED Lighting Systems



LED Flexbrite

Ultra bright, minimum maintenance - the ultimate high end linear light source!



Diameter: 1/2", Bulb Spacing: 1" 

- Bright! 6400°K and 4000°K
- Minimal heat generated for maximum safety
- Long lasting bulbs – up to twelve years!
White 60,000 hours (average life)
All other colors 100,000 hours (average life)
- Flexible
- Field cuttable for maximum flexibility
- Bulb specifications: .06 watts (White, Blue, Green);
.03 watts (Red, Amber, Yellow)
- Voltages: 12V (White) and 120V (all colors)
- Cuttability: 12V–3"; 120V–36" (White, Green, Blue);
120V–60" (Red, Amber, Yellow)
- Maximum run distance: 240 feet–120V; 30 feet–12V
- Indoor & outdoor rated

Item #	Description
LED-DL-COLOR	Bulk LED Rope Light
LED-DL-CONKIT	Bulk Connector Kit
DL-SPL	Splice Connector
DL-EXT-2-KIT	Extensions – to link two sections together, 2 foot and 15 foot lengths
DL-CLIP/SCREW	"U" Shaped Mounting Clip
DL-COND	"P" Shaped Conduit Clip
DL-TRACK-4	4 foot Clear mounting track
DL-CHAN-MG/MS	4 foot Gold/Silver Reflective Channel

Specifications			
	Watts/foot	Cuttability	Max Run
LED-DL-WH	.77	36"	240 feet
LED-DL-GR	.77	36"	240 feet
LED-DL-BL	.77	36"	240 feet
LED-DL-YE	.47	60"	240 feet
LED-DL-RE	.47	60"	240 feet
LED-DL-AM	.47	60"	240 feet
LED-DL-WH-I2V	.77	3"	30 feet

LED Mini-Flex

Ultra-bright, long-life flexible lighting – low maintenance and compact design.

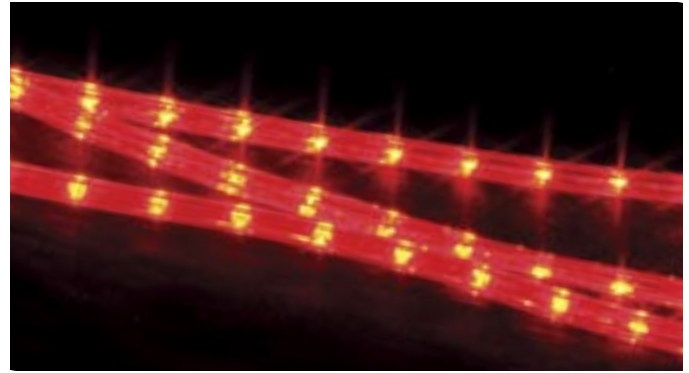

Dimensions: 1/4" x 5/16", Bulb Spacing: 1"

- Bright neon-like light that's easy to use!
- Flexible, ultra slim design
- Easy installation
- Long lasting bulbs – up to twelve years!
White 60,000 hours (average life)
All other colors 100,000 hours (average life)
- Minimal heat generated for maximum safety
- Long run distances – up to 150 feet
- Field cuttable for maximum flexibility
- Voltage: 12V (all colors)
- Bulb Specifications: .06 watt (White, Blue, Green)
.03 watt (Yellow, Red, Amber)
- Floor and aisle lighting retrofit

Item #	Description
LED-MDL-COLOR	Bulk LED Rope Light
LED-MDL-CONKIT	Bulk Connector Kit
LED-MDL-SPL	Splice Connector
LED-MDL-EXT-2-KIT	Two foot extension to link two sections together
PU	Clear polycarbonate "U" channel
PT/PC	PVC Channel with a removable cap for use with concrete

Specifications			
	Watts/foot	Cuttability	Max Run
LED-MDL-WH	.77	3"	30 feet
LED-MDL-GR	.77	3"	30 feet
LED-MDL-BL	.77	3"	30 feet
LED-MDL-YE	.47	3"	30 feet
LED-MDL-RE	.47	3"	30 feet
LED-MDL-AM	.47	3"	30 feet

LED Clip Light Bulbs

A bright, long lasting, miniature bulb great for year-round lighting. Safe, low voltage.

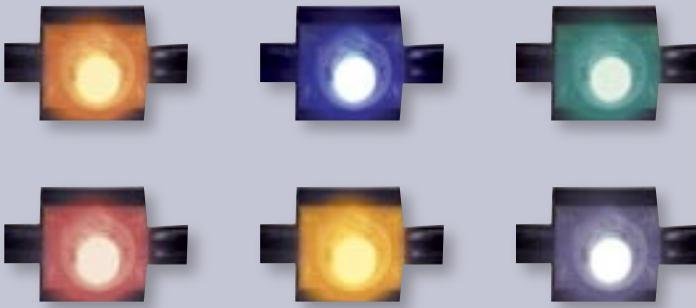

Bulb Height: 5/8", Diameter: 5/16"

- Bright and safe – low voltage LED bulbs eliminate shock hazards
- Long lasting bulbs – up to twelve years!
White 60,000 hours (average life)
All other colors 100,000 hours (average life)
- Energy efficient – only uses .2 watt per bulb
- Colors: Amber, Blue, Green, Red, Yellow and White

Item #	Description
CLED-AM-I2/24	LED Bulbs, I2V
CLED-BL-I2/24	Amber, Blue, Green, Red, Yellow and White
CLED-GR-I2/24	
CLED-RE-I2/24	
CLED-YE-I2/24	
CLED-WH-I2/24	

I2V LED Specifications					
Color	Watts	Maximum Run	Viewing Angle	Wavelength	Average Life (in hours)
Amber	.2	365 bulbs	30°	605mm	100,000
Blue	.2	365 bulbs	30°	468mm	100,000
Green	.2	365 bulbs	30°	520mm	100,000
Red	.2	365 bulbs	30°	630mm	100,000
Yellow	.2	365 bulbs	30°	585mm	100,000
White	.2	365 bulbs	30°	n/a*	60,000

* The color White is made by using blue LEDs covered with a phosphor gas lens.

24V LED Specifications					
Color	Watts	Maximum Run	Viewing Angle	Wavelength	Average Life (in hours)
Amber	.2	730 bulbs	30°	605mm	100,000
Blue	.2	730 bulbs	30°	468mm	100,000
Green	.2	730 bulbs	30°	520mm	100,000
Red	.2	730 bulbs	30°	630mm	100,000
Yellow	.2	730 bulbs	30°	585mm	100,000
White	.2	730 bulbs	30°	n/a*	60,000

* The color White is made by using blue LEDs covered with a phosphor gas lens.

LED Festoon Bulbs

LED Festoon bulbs are perfect for indirect lighting where color is needed.



- Bright and safe - low voltage LED bulbs add color to any application
- Long lasting bulbs – up to twelve years!
White 60,000 hours (average life)
All other colors 100,000 hours (average life)

Item #	Description
LEDF-BL-I2	Colored LED Festoon bulbs, .25 watt per bulb
LEDF-GR-I2	100,000 hours (average life)
LEDF-RE-I2	Yellow, Red, Green, Blue and White
LEDF-WH-I2	
LEDF-YE-I2	

LED MR16's

Spectacular LED effects in a familiar shape that fit most low voltage MR16 fixtures!



Diameter: 1 1/16", Bulb Height: 1 5/8"

- Multiple lighting LED effects – color cross fades, color washes and sparkles
- Long lasting bulbs – up to twelve years!
White 60,000 hours (average life)
RGB and all other colors 100,000 hours (average life)
- 12V DC—not compatible with AC transformers

Item #	Description
LED-MR-16	Color changing LED's – stand alone mode or use Controller for multiple LED effects
LEDMR 16-WH	Color Spot LED MR 16, 2.4 watts, White, Blue, Green, Red, Yellow and Orange
LEDMR 16-BL	
LEDMR 16-GR	
LEDMR 16-RE	
LEDMR 16-YE	
LEDMR 16-OR	

Color-changing LED MR16's contain 17 RGB LED's per bulb. Single-color LED MR16's contain 18 monochromatic LED's per bulb.

LED Tube Light

Energy efficient single color or color changing lighting specifically designed for architectural elements.

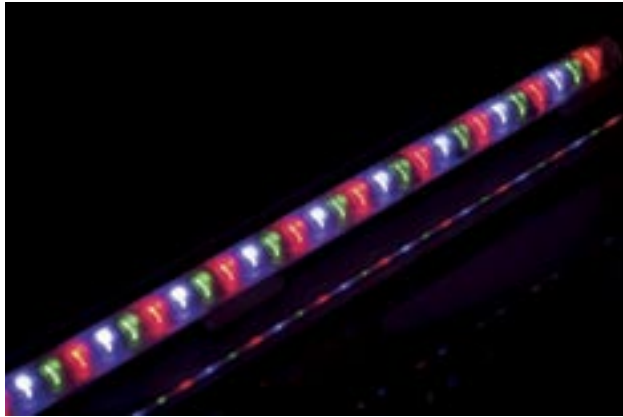

3/4" polycarbonate tube

- Linkable tubes can be installed end-to-end
- Cool operating – LED's produce virtually no heat
- Long lasting bulbs – up to twelve years!
White 60,000 hours (average life)
RGB and all other colors 100,000 hours (average life)
- RGB LED Tubes project thousands of colors with RGB controller
- Color Temperature White: 2800°K and 5000°K

Viewing Angles Available			
	30°	50°	80°
Characteristics	Strong intensity High visibility	Medium intensity Good visibility	Diffused Softened effect
Applications	Signs Outlines	Backlighting	Coves Color washes Accent lighting

Item #	Description
LEDT-COLOR-24/FT	Single Color LED Tube, 12V DC
LEDT-COLOR-48/FT	24 or 48 LED's per foot Red, Amber, Green, White, Blue Sold in 6" increments
LEDT-RGB-24/FT	RGB LED Tube, 12V DC
LEDT-RGB-48/FT	24 or 48 LED's per foot Sold in 9" increments
LEDMC-8.5	RGB Master Controller, Functions: Color fade, select color and brightness
LEDSSL-12	RGB Slave Controller to be linked to LEDMC-8.5 on runs of 16 foot or more
LEDCC	Cable for linking master & slave
LEDCC-CON	Male and female connectors
LEDT-CLIP	Mounting Clip, 1" long
LEDPS-3.3	12V DC power supply
LEDPS-5.0	3.5, 5.0, 8.5 amps
LEDPS-8.5	Dimensions: 8" x 4" x 1.5",
LEDPS-12.5	12.5 amps, dimensions: 8" x 5" x 2"
LEDPS-18	and 18 amps, dimensions: 8" x 4" x 3"
LED-DR-12	Regulated Driver, up to 25 watts, 12V DC

Specifications					
	Watts/foot	Amps/foot	Max Tube Run	Max Run per Controller	Add'l Run per Slave
LED 24/FT (single color)	2.4	.25	12 feet	n/a	n/a
LED 48/FT (single color)	4.8	.50	8 feet	n/a	n/a
LED 24/FT (RGB)	2.4	.24	12 feet	16 feet	21 feet
LED 48/FT (RGB)	4.8	.50	9 feet	8 feet	10 feet

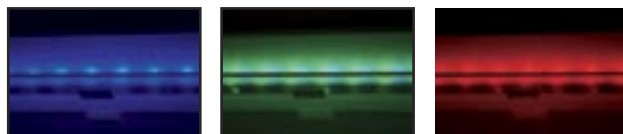

RGB Tubes create intense and dramatic lighting effects allowing the ultimate in color control.



LED Mini Light Strings

Save 80-90% in electricity costs with cool burning Mini Lights in a size C6.



- Uses 80-90% less electricity 
- Long lasting bulbs – up to twelve years!
White 60,000 hours (average life)
All other colors 100,000 hours (average life)
- Rugged – no glass bulbs to break
- Minimal heat generated for maximum safety
- Brilliant colors that will not fade or flake
- Wired in parallel – when one bulb fails the rest stay lit
- 4” bulb spacing on 20 gauge wire
- For indoor and outdoor use
- Individual bulbs can be changed easily
- Plug strings end-to-end

Item #	Description
C6LED35-G-COLOR	LED C6 Light String, 120V, 1.4 watts 35 lights per string, Green wire Multi, White, Red, Green, Blue and Yellow

LED Edgelit Signage

Sleek, low maintenance bases light up corporate ID's, product recognition and are an energy efficient EXIT sign alternative.



Lengths: 12", 18" and 24". Acrylic will be $\frac{3}{8}$ " shorter than the length of the base

- Eye catching neon-like glow
- Bright colors that will not fade
- Custom designs, acrylic sold separately
- Cool operating – emits virtually no heat
- Long lasting bulbs – up to twelve years!
White 60,000 hours (average life)
All other colors 100,000 hours (average life)
- Wall mount, ceiling mount and desk/counter bases available
- Acrylic panel available in “ice-break” and solid edge
- Acrylic will be $\frac{3}{8}$ " shorter than the length of the base

Item #	Description
ELBLED-*	LED Edgelit Base Red, Amber, Blue, Green, Orange and White $\frac{3}{8}$ " thick acrylic

*Specify mounting, color and acrylic edge style



Bright, energy efficient LED's bring light to dark areas of the home.

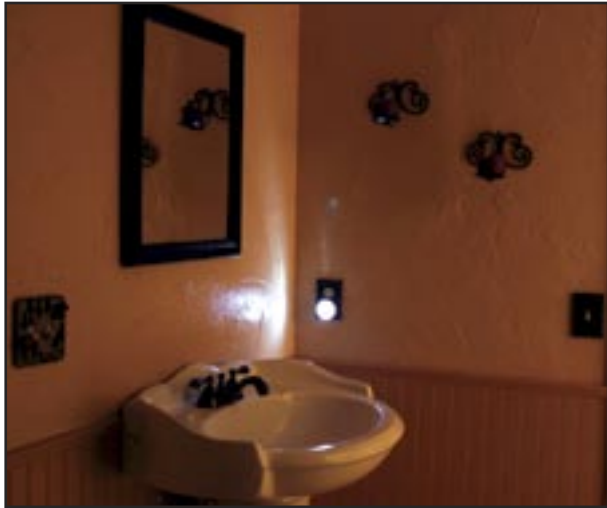

NL-05

- Multi function LED Night Lite
- Motion sensor and photocell
- Options include: "motion", "always-on" and "photocell" mode



NL-01 (White)

- Diameter: 2 3/8", Height: 1 1/8"
- No heat
- Very low energy usage
- No bulb to replace
- Low profile design
- Long life bulb lasts up to ten years!
White LEDs 60,000 hours (average life)
Blue and RGB 100,000 hours (average life)

NL-02 (Blue)

- Diameter: 2 3/8", Height: 1 1/8"

NL-03 (RGB-Color Changing)

- Diameter: 2 3/8", Height: 1 1/8"



NL-04

- High/Low LED Night Lite
- Motion sensor and photocell
- "Low" level comes on at dusk
- When "motion" is detected, light turns to "High" light level



NL-06

- Three-in-One Utility LED Night Lite
- Rechargeable flash light
- Photocell
- Emergency light in the event of power failure



NL-07

- Fiber Optic LED Night Lite
- Photocell
- Changeable Fiber Optic cartridge (Blue, Green and White included)

American Lighting's transformers are designed to operate quietly and efficiently while providing safe power conversion. When using American Lighting's low voltage lighting products, always use American Lighting's transformers to ensure safety and retain product warranty.

Which transformer is right for you – Magnetic or Electronic?

Magnetic transformers are perfect for large applications (over 300 watts) that require the transformer to be remote mounted in distances greater than 10 feet from the lighting system or for outdoor applications. These transformers range from 150 watts to 1200 watts and are available in 12V and 24V versions.

Electronic transformers are compact in size and ideal for applications where small size and close placement are issues. Both magnetic and electronic transformers are dimmable with standard incandescent dimmers.



Magnetic Transformers

Efficient, inexpensive and compact for your low voltage lighting needs.



- Whisper quiet operation, even when dimmed
- Compact size and innovative design has reduced overall dimensions
- Efficient and dependable – 94% efficiency rating
- Easy installation, multiple knockouts available
- Magnetic circuit breakers protect each circuit
- Five year warranty
- Rating: NEMA 3R for indoor and outdoor use
- Boost tap for longer runs
- Black powder coated finished with stainless steel enclosure

Item #	Description
TR-150-12	150 watts, 12V, (1) 15 amp circuit
TR-150-24	150 watts, 24V, (1) 7 amp circuit Dimensions: 8.5"x3.5"x3.5"
TR-300-12	300 watts, 12V, (1) 25 amp circuit
TR-300-24	300 watts, 24V, (1) 15 amp circuit Dimensions: 9"x4.5"x4.5"
TR-300-PT-12	300 watts, 12V with photocell and timer Dimensions: 10"x4.5"x4.5"
TR-600-12	600 watts, 12V, (2) 25 amp circuits
TR-600-24	600 watts, 24V, (1) 15 amp circuit Dimensions: 9.5"x5"x5"
TR-900-12	900 watts, 12V, (3) 25 amp circuits
TR-900-24	900 watts, 24V, (2) 25 amp circuits Dimensions: 10.5"x5.5"x5.5"
TR-1200-12	1200 watts, 12V, (4) 25 amp circuits
TR-1200-24	1200 watts, 24V, (2) 25 amp circuits Dimensions: 10.5"x6.5"x6.5"

Electronic Transformers

Compact electronic transformers pack a powerful punch.



- Small compact size
- Quiet operation
- Efficient and dependable
- Four year warranty
- Overload and short circuit protection
- Multiple knockouts on 150 watt and 300 watt models
- DC regulated transformers allow for longer runs without voltage drop

Item #	Description
TRE-75-12	75 watts, hardwire, 12V and 24V
TRE-75-24	Remote transformer in steel housing Overload and short circuit protection
TRE-80-12	80 watts, hardwire, 12V
TRE-150-12	150 watts, hardwire, 12V and 24V
TRE-150-24	Remote transformer in steel housing Overload and short circuit protection Features 6 knockouts for easy installation
TRE-300-12	300 watts, hardwire, 12V and 24V
TRE-300-24	Remote transformer in steel housing Overload and short circuit protection Features 6 knockouts for easy installation
TRE-150-12-DC	150 or 300 watts, hardwire, 12V DC
TRE-300-12-DC	Remote transformer in steel housing Allows for longer maximum run distances (up to 25 feet) Features 6 knockouts for easy installation

See page 28 for other electronic transformer models.

Electronic Transformers



ALTR60B*/ALTR60BP*

- 60 watt hardwire 12V remote transformer in plastic housing
- Auto reset/thermal protection against heat and shorts

* B=Bulk and BP=Blister Pack



ALTR80B*/ALTR80BP*

- 80 watt hardwire 12V remote transformer in plastic housing
- Auto reset/thermal protection against heat and shorts

* B=Bulk and BP=Blister Pack



ALTR105B*/ALTR105BP*

- 105 watt hardwire 12V remote transformer in plastic housing
- Auto reset/thermal protection against heat and shorts

* B=Bulk and BP=Blister Pack



ALTR150B*/ALTR150BP*

- 150 watt hardwire 12V remote transformer in plastic housing
- Auto reset/thermal protection against heat and shorts

* B=Bulk and BP=Blister Pack

Plug-in Electronic Transformers



ALTR60PI

- 60 watt plug-in 12V transformer
- Two foot lead with puck connector block
- On/off roll switch
- Auto reset/thermal protection
- Blister Pack



ALTR60

- 60 watt remote 12V transformer
- 8 foot power cord with 2 foot lead and puck connector block
- On/off roll switch
- Auto reset/thermal protection
- Blister Pack



ALTR120

- 120 watt remote 12V transformer
- 8 foot power cord with 2 foot lead and puck connector block
- On/off roll switch
- Auto reset/thermal protection
- Blister Pack

Dimmers



ALDIM200

- 200 watt replacement lamp dimmer, 120V
- Includes gold knob
- For use with torchieres and table lamps

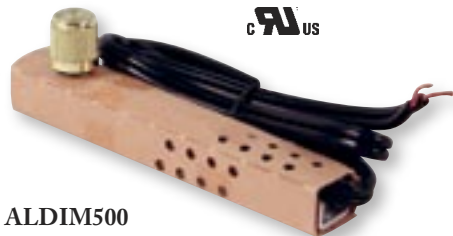

ALDIM500

- 500 watt replacement lamp dimmer, 120V
- Includes gold knob
- For use with torchieres and table lamps



ALTDIM

- 200 watt Halogen, Xenon and Incandescent dimmer, 120V
- Three light levels, plus off
- Converts any lamp with metal to touch control
- Easy to install, universal replacement



ALLHDIM

- 150 watt Halogen, Xenon and Incandescent dimmer, 120V
- Converts any lamp with metal to touch lamp
- Three light levels

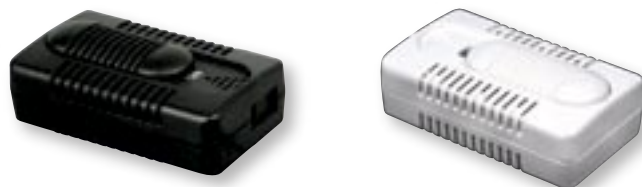

ALDIMF500/ALDIMF500W

- 500 watt plug-in foot dimmer
- Sturdy design, fused
- Slide control allows easy dimming

Touch Control Dimmers



ALTDPI

- 200 watt Halogen, Xenon and Incandescent dimmer, 120V
- Converts any lamp with metal to a touch lamp
- Use regular bulb instead of 3-way bulb
- No wiring, just plug-in light fixture



ALTPDPI

- 200 watt Halogen, Xenon and Incandescent dimmer, 120V
- Converts lamp to touch control
- No wiring, just plug-in light fixture
- 3-Level touch pad dimming for tabletops and workstations

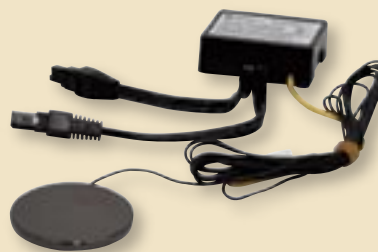

ALLVPTDIM

- 300 watt Halogen, Xenon and Incandescent dimmer
- Converts 120V products to touch control
- No wiring, just plug-in
- Hinge or touch pad dimmer
- Touch pad allows for 3-Level control (Hi/Medium/Low) and off



ALTPDIM

- Hinge or Touch Pad Dimmer
- 300 watt Halogen, Xenon and Incandescent, 120V
- Touch pad allows for 3-Level control (Hi/Medium/Low) and off
- Attach up to five 60 watt plug-in puck light transformers

Heavy-duty chase controllers provide years of trouble free service.



ALSENSI

- Automatic Light Control
- Use dial to adjust light sensitivity
- Automatic “on” at dusk and “off” at dawn
- 150 watts maximum, Incandescent lamps only



ALSENSPAR

- Automatic Outdoor Light Control
- 150 watts maximum, Incandescent lamps only
- Short stem design fits inside most exterior fixtures
- Twist shutter housing to adjust light sensitivity



ALSENPI

- Automatic Light Control—Plug-in
- 300 watts maximum
- Automatic “on” at dusk and “off” at dawn
- Incandescent lamps only
- For indoor use only



ALSENSPIDIM

- Digital “Auto Light Control” for Compact Fluorescent (PL) bulbs
- Automatic “on” at dusk and “off” at dawn
- 300 watts maximum



- Two, three or four channel controllers
- Fuse protection
- AC operation
- Limited lifetime warranty

Item #	Hardwire Description
CON-3-2	Controller, 3 amps per channel
CON-3-3	One direction chase with speed control
CON-3-4	2, 3 or 4 channels, 12V/24V/120V, fused
CON-6-2	Controller, 6 amps per channel
CON-6-3	One direction chase with speed control
CON-6-4	2, 3 or 4 channels, 12V/24V/120V, fused
CON-10-2	Controller, 10 amps per channel
CON-10-3	One direction chase with speed control
CON-10-4	2, 3 or 4 channels, 12V/24V/120V, fused

Custom controllers available. Please call for assistance.

Decorative Plant Light

Create dramatic accent lighting for indoor plants.



Each light is 6 3/4" high with 2 3/16" diameter housing



- Adjustable, compact and ready-to-use
- Stakes anchor lights firmly into soil
- Each pair of lights is pre-wired onto six-foot cord with convenient On/Off switch
- Clear, protective lamp cover

Item #	Description
DPL-90000	Decorative Plant Light - Retail Box Includes (2) 10 watt Halogen light stakes and two spare bulbs for future use

Plant Lights are for indoor use only.



Decorative Up Light

Adjustable mini spot that highlights artwork, architectural details, foliage and collectibles.



Height: 6", Length: 6 3/16", Width: 4 7/8"



- Sleek and compact – only 6" high
- Ready to use – just plug it in
- Full 360° swivel
- Convenient On/Off switch

Item #	Description
ALUL50S	Decorative Up Light - Retail Box
ALUL50W	Includes (1) 50 watt lamp Silver and White

Decorative Up Lights are for indoor use only.



Long Life Bulbs

High quality bulbs that last—available in a wide variety of shapes and colors!



BA19-Clear



BA15-Frosted



B11S14-Yellow



B7.5S11-Blue



B10S11-Green



B7.5C-Red

- Extra thick glass
- Long life filaments
- Waterproof colors
- Nickel base
- Extra filament supports
- 3,000–8,000 hours (average life)

Item #	Description
B7.5S11-CL	Medium base B7.5S11 bulb
B7.5S11-COLOR	7.5 watts, 8,000 hours, 130V, G12.5 Clear, Frosted, Red, Blue, Green, Yellow, Amber, White
B11S14-CL	Medium base B11S14 bulb
B11S14-COLOR	11 watts, 8,000 hours, 130V, Clear, Frosted, Red, Blue, Green, Yellow, Amber, White
B10S11-CL	Intermediate base B10S11 bulb
B10S11-COLOR	10 watts, 8,000 hours, 130V Clear, Frosted, Red, Blue, Green, Yellow, Amber, White
B7.5C-CL	Candelabra base B7.5C bulb
B7.5C-COLOR	7.5 watts, 8,000 hours, 130V, G11 Clear, Frosted, Red, Blue, Green, Yellow, Amber, White
C7-5-COLOR	Candelabra Base C7 bulb 5 watts, 3,000 hours, 130V Clear, Red, Blue, Green, Pink Purple, Yellow, Teal, Amber, Assorted
C9-7-COLOR	Intermediate Base C9 bulb 7 watts, 3,000 hours, 130V Clear, Red, Blue, Green, Pink, Purple, Yellow, Teal, Amber, Assorted
BA19-CL	Medium base, A19 bulb, 25 watts, 3,000 hours, 130V clear
BA15-FR	Medium base, A15 bulb, 15 watts, 3,000 hours, 130V clear

Bulbs are sold in full box (25) multiples only.

MR16 Attachments

Dramatic lighting accents that simply clip on to an MR16 lamp!



MR-HON



MR-LOU-P



MR-DB-RED



MR-DB-GREEN



MR-DB-BLUE

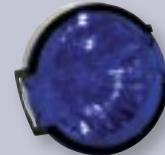

MR-CLIP-FIL-BLUE



MR-CLIP-FIL-GREEN



MR-CLIP-FIL-RED



MR-BD-SI















MR-BD-BK





- Easy to use
- Decorative and unique
- Durable – made of stainless steel
- Use together in creative combinations!

Item #	Description
MR-BD-BK	Barndoors, Black and Silver
MR-BD-SI	Direct light, reduce glare Can be used in pairs
MR-LOU-P	Parallel Louvers, Black Rotate for glare protection, combine with barndoors
MR-HON	Honey Comb Filter, Black Reduce glare and peripheral light, combine with barndoors Requires MR-CLIP, sold separately
MR-DB	Decorative Clip Holder for MR-DB-COLOR, sold separately
MR-DB-COLOR	Decorative Color Ball Three eye catching colors: Red, Green and Blue Requires MR-DB, sold separately
MR-CLIP	Filter Clip, Black Use with MR-HON or MR-FIL, sold separately
MR-FIL-COLOR	Colored Filter Create eye catching color washes in Red, Green and Blue Requires MR-CLIP, sold separately

Bulb Specifications

		Item Number	Volts	Watts	Lumens	Approx. Color Temp (Kelvin)	Average Life (in hours)	Base
12 Volts		AL20B	12V	20w	145	2700	2,000	G4
		ALX10BX	12V	10w	140	2700	10,000	G4
		ALPXP20BP	12V	20w	235	3000	10,000	G4
		BC-3-12	12V	3w	14	2550	3,000	Wedge
		BX-5-12	12V	5w	33	2550	10,000	Wedge
		CL-BULB-12	12V	.5w	2	2500	25,000	Wedge
		FSL-5-12	12V	5w	33	2550	20,000	Festoon
		FSL-10-12	12V	10w	83	2650	20,000	Festoon
		FSL-5F-12	12V	5w	33	2550	15,000	Festoon
		FSL-10F-12	12V	10w	83	2700	15,000	Festoon
	MR-11-12-20	12V	20w	220	3000	2,000	G4	

		Item Number	Volts	Watts	Lumens	Approx. Color Temp (Kelvin)	Average Life (in hours)	Base
24 Volts		BC-3-24	24V	3w	14	2650	3,000	Wedge
		BX-5-24	24V	5w	33	2650	10,000	Wedge
		CL-BULB-24	24V	.96w	4	2500	25,000	Wedge
		FSL-5-24	24V	5w	33	2550	20,000	Festoon
		FSL-10-24	24V	10w	83	2650	20,000	Festoon
		FSL-5F-24	24V	5w	31	2550	15,000	Festoon
		FSL-10F-24	24V	10w	79	2650	15,000	Festoon
		MR-11-24-20	24V	20w	230	2700	2,200	G4
	TL-BULB-24	24V	.96w	4	2500	25,000	Wedge	

		Item Number	Volts	Watts	Lumens	Approx. Color Temp (Kelvin)	Average Life (in hours)	Base
120 Volts		ALFL8B	120V	8w	440	3100	8,000	T4 Bi-Pin
		ALFL16B	120V	16w	960	3100	8,000	T4 Bi-Pin
		ALLVP20B	120V	20w	145	2600	2,500	G8
		LHC35B-BP	120V	35w	390	2600	2,500	G8
		LXCP-20BP	120V	20w	165	2600	8,000	G8

Photometric Data

Ultra Thin Fluorescent Light	
A) 28.8	A1) 33.2
B) 32.9	B1) 35.9
C) 29.2	C1) 30.5
D) 23.8	D1) 23.2

Clear Rope Light	
A) 5.2	A1) 4.6
B) 5.6	B1) 5.3
C) 5.4	C1) 5.3
D) 4.9	D1) 4.7

Brite-Line	
A) 9.4	A1) 8.3
B) 10.2	B1) 9.9
C) 9.3	C1) 9.3
D) 8.6	D1) 7.8

Fluorescent Task Light	
A) 15.8	A1) 17.5
B) 17.6	B1) 19.2
C) 13.5	C1) 15.2
D) 9.5	D1) 10.3

Halogen 120V Puck Light	
A) 21.1	A1) 11.3
B) 27.1	B1) 12.7
C) 18.1	C1) 10.1
D) 10.2	D1) 8.0

21" Adjustable Fluorescent Light	
A) 100.7	A1) 101.0
B) 99.6	B1) 105.7
C) 66.9	C1) 71.0
D) 39.0	D1) 41.1

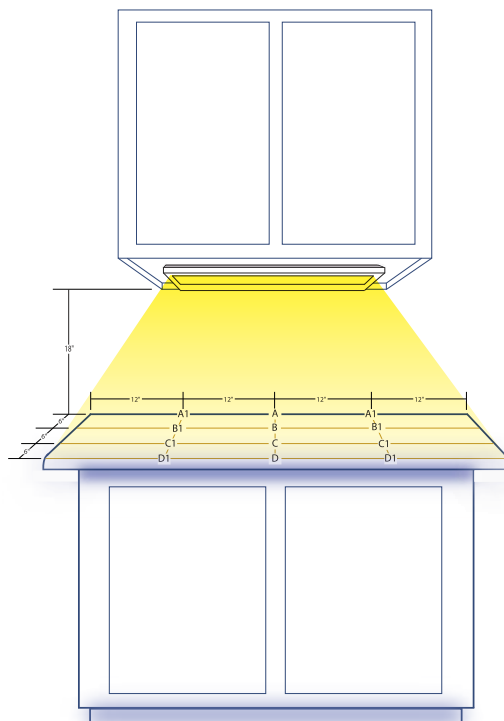

Halogen 12V Puck Light	
A) 30.8	A1) 21.6
B) 37.7	B1) 26.0
C) 27.8	C1) 20.8
D) 14.7	D1) 12.9

16" Halogen Under Cabinet Light	
A) 53.8	A1) 53.5
B) 63.9	B1) 62.4
C) 51.8	C1) 51.7
D) 33.9	D1) 35.0



Xenon 120V Puck Light	
A) 23.2	A1) 12.5
B) 31.3	B1) 14.7
C) 19.1	C1) 12.9
D) 10.1	D1) 9.8

Data shown above, expressed in foot candles, is a result of a single fixture, with the exception of Clear Rope Light. Counter top reflectance 15%. Rear wall reflectance 50%. See diagram for points of measurement.

16" Xenon Under Cabinet Light	
A) 43.5	A1) 41.1
B) 49.3	B1) 47.0
C) 39.9	C1) 38.1
D) 26.5	D1) 26.0

Xenon 12V Puck Light	
A) 33.9	A1) 23.9
B) 43.6	B1) 30.1
C) 29.3	C1) 26.5
D) 14.6	D1) 15.8

Universal Accessories

Direct Wire Boxes	Item Number	Description	Compatibility
	ALHWBOX ALHWBOX-WH	Direct Wire Box with (2) 120V outlets (2) On/Off switches, Black or White	Use with 120V Xenon and Halogen Plug-in Under Cabinet Lights, 120V Xenon and Halogen Puck Lights and all Fluorescent Task Light Fixtures
	ALSLHWBOX ALSLHWBOX-WH	Slim Line Direct Wire Box with (2) molex outlets rated at 15 amps, Black or White	Use with 120V Xenon and Halogen Plug-in Under Cabinet Lights, 120V Xenon and Halogen Puck Lights and all Fluorescent Task Light Fixtures

Linkable Connectors:	Item Number	Description	Compatibility
	ALLVPEX 12 ALLVPEX 12WH ALLVPEX24 ALLVPEX24WH	12" and 24" Extension cables link up to six fluorescent task lights and up to ten incandescent light fixtures Black or White	120V Xenon and Halogen Puck Lights and all Fluorescent Task Light Fixtures

Power Cords:	Item Number	Description	Compatibility
	ALLVPPC6 ALLVPPC6WH ALLVPPC6-B	6 foot Power cords link up to six fluorescent task lights and up to ten incandescent light fixtures Black (Bulk or Blister Pack) and White (Blister Pack only)	120V Xenon and Halogen Puck Lights and all Fluorescent Task Light Fixtures

Dimmer:	Item Number	Description	Compatibility
	ALLVPTDIM	Touch Pad Dimmer for 120V products 300 watt touch dimmer with 6" input cord and 6" output cord	120V Xenon and Halogen Puck Lights

Power Strip:	Item Number	Description	Compatibility
	PS-6	15 amps maximum Six outlets available Fused for safety Six foot power cord Bulk packaging	Use with any 120V plug-in electrical product



AMERICAN LIGHTING

BRIGHT IDEAS • INNOVATIVE PRODUCTS

Corporate Headquarters

American Lighting, Inc.
7660 East Jewell Avenue, Suite A
Denver, Colorado 80231
800-880-1180 • Order Fax 303-695-7633
www.americanlighting.com

Showrooms

Dallas Market Center #4408, Dallas, TX
Corporate Offices, Denver, CO