



Installation Instructions

FLEX I/O 8 Relay Output Module

Cat. No. 1794-OW8, 1794-OW8K, 1794-OW8XT

(Modules with catalog numbers that end in K are conformally coated to meet noxious gas requirements of ISA/ANSI-71.040 1985 Class G3 Environment.)

Important User Information

Solid state equipment has operational characteristics differing from those of electromechanical equipment. Safety Guidelines for the Application, Installation and Maintenance of Solid State Controls (Publication SGI-1.1 available from your local Rockwell Automation sales office or online at <http://www.literature.rockwellautomation.com>) describes some important differences between solid state equipment and hard-wired electromechanical devices. Because of this difference, and also because of the wide variety of uses for solid state equipment, all persons responsible for applying this equipment must satisfy themselves that each intended application of this equipment is acceptable.

In no event will Rockwell Automation, Inc. be responsible or liable for indirect or consequential damages resulting from the use or application of this equipment.

The examples and diagrams in this manual are included solely for illustrative purposes. Because of the many variables and requirements associated with any particular installation, Rockwell Automation, Inc. cannot assume responsibility or liability for actual use based on the examples and diagrams.

No patent liability is assumed by Rockwell Automation, Inc. with respect to use of information, circuits, equipment, or software described in this manual.

Reproduction of the contents of this manual, in whole or in part, without written permission of Rockwell Automation, Inc. is prohibited.

Throughout this manual we use notes to make you aware of safety considerations.

WARNING

Identifies information about practices or circumstances that can cause an explosion in a hazardous environment, which may lead to personal injury or death, property damage, or economic loss.



IMPORTANT

Identifies information that is critical for successful application and understanding of the product.

ATTENTION

Identifies information about practices or circumstances that can lead to personal injury or death, property damage, or economic loss. Attentions help you identify a hazard, avoid a hazard, or recognize the consequence



ATTENTION

Environment and Enclosure



This equipment is intended for use in a Pollution Degree 2 industrial environment, in overvoltage Category II applications (as defined in IEC 60664-1), at altitudes up to 2000 m (6562 ft) without derating.

This equipment is considered Group 1, Class A industrial equipment according to IEC/CISPR 11. Without appropriate precautions, there may be difficulties with electromagnetic compatibility in residential and other environments due to conducted and radiated disturbances.

This equipment is supplied as open-type equipment. It must be mounted within an enclosure that is suitably designed for those specific environmental conditions that will be present and appropriately designed to prevent personal injury resulting from accessibility to live parts. The enclosure must have suitable flame-retardant properties to prevent or minimize the spread of flame, complying with a flame spread rating of 5VA, V2, V1, V0 (or equivalent) if non-metallic. The interior of the enclosure must be accessible only by the use of a tool. Subsequent sections of this publication may contain additional information regarding specific enclosure type ratings that are required to comply with certain product safety certifications.

In addition to this publication, see:

- Industrial Automation Wiring and Grounding Guidelines, publication [1770-4.1](#), for additional installation requirements.
- NEMA Standard 250 and IEC 60529, as applicable, for explanations of the degrees of protection provided by enclosures.

ATTENTION



FLEX I/O is grounded through the DIN rail to chassis ground. Use zinc plated yellow-chromate steel DIN rail to assure proper grounding. The use of other DIN rail materials (for example, aluminum or plastic) that can corrode, oxidize, or are poor conductors, can result in improper or intermittent grounding. Secure DIN rail to mounting surface approximately every 200 mm (7.8 in.) and use end-anchors appropriately.

ATTENTION



Preventing Electrostatic Discharge

This equipment is sensitive to electrostatic discharge, which can cause internal damage and affect normal operation. Follow these guidelines when you handle this equipment:

- Touch a grounded object to discharge potential static.
- Wear an approved grounding wriststrap.
- Do not touch connectors or pins on component boards.
- Do not touch circuit components inside the equipment.
- Use a static-safe workstation, if available.
- Store the equipment in appropriate static-safe packaging when not in use.

WARNING



If you connect or disconnect wiring while the field-side power is on, an electrical arc can occur. This could cause an explosion in hazardous location installations. Be sure that power is removed or the area is nonhazardous before proceeding.

ATTENTION



Personnel responsible for the application of safety-related programmable electronic systems (PES) shall be aware of the safety requirements in the application of the system and shall be trained in using the system.

ATTENTION



Do not remove or replace a Terminal Base unit while power is applied. Interruption of the backplane can result in unintentional operation or machine motion.

ATTENTION



To comply with the CE Low Voltage Directive (LVD), this equipment must be powered from a source compliant with the following: Safety Extra Low Voltage (SELV) or Protected Extra Low Voltage (PELV).

European Hazardous Location Approval

The following applies when the product bears the Ex Marking.

This equipment is intended for use in potentially explosive atmospheres as defined by European Union Directive 94/9/EC and has been found to comply with the Essential Health and Safety Requirements relating to the design and construction of Category 3 equipment intended for use in Zone 2 potentially explosive atmospheres, given in Annex II to this Directive.

Compliance with the Essential Health and Safety Requirements has been assured by compliance with EN 60079-15 and EN 60079-0.

WARNING



- Observe the following additional Zone 2 certification requirements.
- This equipment is not resistant to sunlight or other sources of UV radiation.
 - This equipment must be installed in an enclosure providing at least IP54 protection when applied in Zone 2 environments.
 - This equipment shall be used within its specified ratings defined by Rockwell Automation.
 - Provision shall be made to prevent the rated voltage from being exceeded by transient disturbances of more than 40% when applied in Zone 2 environments.
 - This equipment must be used only with ATEX certified Rockwell Automation terminal bases.
 - Secure any external connections that mate to this equipment by using screws, sliding latches, threaded connectors, or other means provided with this product.
 - Do not disconnect equipment unless power has been removed or the area is known to be nonhazardous.

North American Hazardous Location Approval

The 1794-OW8, 1794-OW8K, 1794-OW8XT modules are Hazardous Location approved.

<p>The following information applies when operating this equipment in hazardous locations:</p>	<p>Informations sur l'utilisation de cet équipement en environnements dangereux :</p>
<p>Products marked "CL I, DIV 2, GP A, B, C, D" are suitable for use in Class I Division 2 Groups A, B, C, D, Hazardous Locations and nonhazardous locations only. Each product is supplied with markings on the rating nameplate indicating the hazardous location temperature code. When combining products within a system, the most adverse temperature code (lowest "T" number) may be used to help determine the overall temperature code of the system. Combinations of equipment in your system are subject to investigation by the local Authority Having Jurisdiction at the time of installation.</p>	<p>Les produits marqués "CL I, DIV 2, GP A, B, C, D" ne conviennent qu'à une utilisation en environnements de Classe I Division 2 Groupes A, B, C, D dangereux et non dangereux. Chaque produit est livré avec des marquages sur sa plaque d'identification qui indiquent le code de température pour les environnements dangereux. Lorsque plusieurs produits sont combinés dans un système, le code de température le plus défavorable (code de température le plus faible) peut être utilisé pour déterminer le code de température global du système. Les combinaisons d'équipements dans le système sont sujettes à inspection par les autorités locales qualifiées au moment de l'installation.</p>

WARNING



- EXPLOSION HAZARD**
- Do not disconnect equipment unless power has been removed or the area is known to be nonhazardous.
 - Do not disconnect connections to this equipment unless power has been removed or the area is known to be nonhazardous. Secure any external connections that mate to this equipment by using screws, sliding latches, threaded connectors, or other means provided with this product.
 - Substitution of components may impair suitability for Class I, Division 2.
 - If this product contains batteries, they must only be changed in an area known to be nonhazardous.

AVERTISSEMENT



- RISQUE D'EXPLOSION**
- Couper le courant ou s'assurer que l'environnement est classé non dangereux avant de débrancher l'équipement.
 - Couper le courant ou s'assurer que l'environnement est classé non dangereux avant de débrancher les connecteurs. Fixer tous les connecteurs externes reliés à cet équipement à l'aide de vis, loquets coulissants, connecteurs filetés ou autres moyens fournis avec ce produit.
 - La substitution de composants peut rendre cet équipement inadapté à une utilisation en environnement de Classe I, Division 2.
 - S'assurer que l'environnement est classé non dangereux avant de changer les piles.

Installing Your Relay Output Module

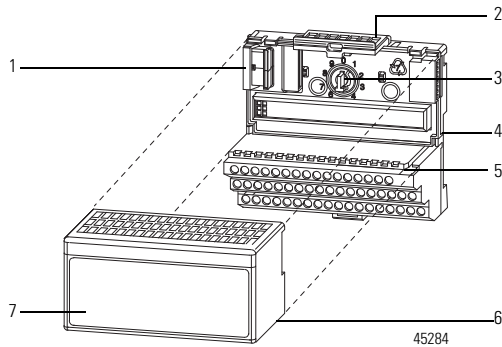

ATTENTION



During mounting of all devices, be sure that all debris (for example, metal chips and wire strands) is kept from falling into the module. Debris that falls into the module could cause damage on power up.

ATTENTION



Allow 25.4 mm (1 in.) of space between adjacent equipment for adequate ventilation.

The module mounts on a 1794 terminal base.

1. Rotate the keyswitch (3) on the terminal base (4) clockwise to position 9 as required for this type of module.
2. Make certain the flexbus connector (1) is pushed all the way to the left to connect with the neighboring terminal base and adapter. **You cannot install the module unless the connector is fully extended.**
3. Make sure the pins on the bottom of the module are straight so they will align properly with the connector in the terminal base.

WARNING



If you remove or insert the module while the backplane power is on, an electrical arc can occur. This could cause an explosion in hazardous location installations. Be sure that power is removed or the area is nonhazardous before proceeding.

4. Position the module (7) with its alignment bar (6) aligned with the groove (5) on the terminal base.
5. Press firmly and evenly to seat the module in the terminal base unit. The module is seated when the latching mechanism (4) is locked into the module.

WARNING



Exposure to some chemicals may degrade the sealing properties of materials used in the following devices:
Relay K1 through K8, Epoxy.
It is recommended that the User periodically inspect these devices for any degradation of properties and replace the module if degradation is found.

Simplified Schematic of the Relay Module

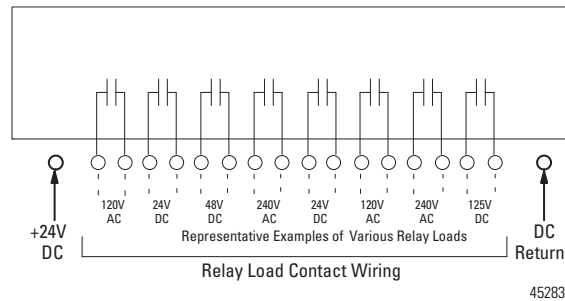

Load power can be obtained from a variety of sources, and can range from +5V...240V AC. Make certain that only 24V DC is applied to the module power terminals on the module terminal base unit.
If you are using 220/240V AC power, you must use the 1794-TBN or 1794-TBNF terminal base unit. Maximum voltage allowed is shown below.

Working Voltage and Isolation Voltage Ratings

Terminal Base	24V	120V	230V	Isolation Voltage
1794-TBN, 1794-TBNK, 1794-TBNF, 1794-TBNFK	AC/DC	AC/DC	AC/DC	Dependent upon installed module - refer to individual installation instructions for your specific module.
1794-TB2, 1794-TB3, 1794-TB3K, 1794-TB3S	AC/DC	AC/DC		
1794-TB3T, 1794-TB3TS	AC/DC	AC/DC		
1794-TB3G, 1794-TB3GK, 1794-TB3GS	AC/DC			
1794-TB32, 1794-TB32S	AC/DC			
1794-TBKD	DC	AC		

ATTENTION If multiple power sources are used, do not exceed the specified isolation voltage.



ATTENTION Apply only 24V DC power to the power terminals on the terminal base unit. Make certain that **all** relay wiring is properly connected before applying any power to the module.



ATTENTION Total current through the terminal base unit is limited to 10 A. Separate power connections to the terminal base unit may be necessary.



ATTENTION Do not attempt to increase load current or wattage capability beyond the maximum rating by connecting 2 or more outputs in parallel. The slightest variation in relay switching time may cause one relay to momentarily switch the total load current.



Wiring to a 1794-TB2, 1794-TB3 or 1794-TB3S Terminal Base Unit

1. Connect individual output relay contact (customer load) wiring to numbered terminals on the **0...15** row (A) as indicated in the table below. The even numbered terminals are one pole of the relay contacts; the odd numbered terminals are the other pole of the relay contacts.
2. Connect 24V DC return to terminal 16 on the **16...33** row (B).
3. Connect +24V DC power to terminal 34 on the **34...51** row (C).

ATTENTION Apply only 24V DC power to the power terminals on the terminal base unit. Make certain that **all** relay wiring is properly connected before applying any power to the module.



4. If daisy chaining power to the next terminal base, connect a jumper from terminal 51 (+V DC) on this base unit to terminal 34 on the next base unit.
5. If continuing DC common to the next base unit, connect a jumper from terminal 33 (common) on this base unit to terminal 16 on the next base unit.

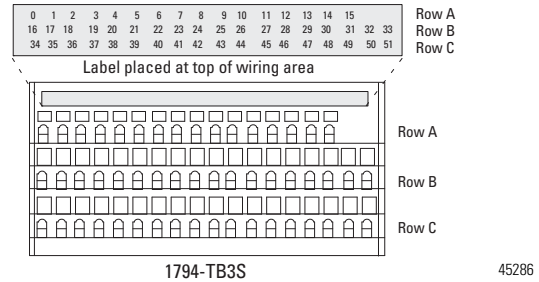
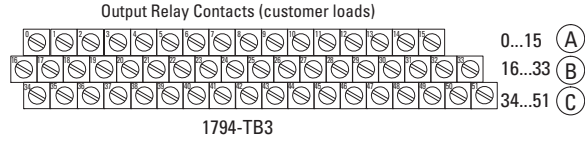
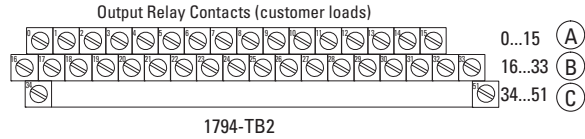

Wiring to a 1794-TBN or 1794-TBNF Terminal Base Unit

1. Connect individual output relay contact (customer load) to even numbered terminals 0...14 on row (B) and odd numbered terminals 1...15 on row (C) as indicated in the table below. The even numbered terminals are one pole of the relay contacts; the odd numbered terminals are the other pole of the relay contacts.

ATTENTION When using 240V power to a relay, you must connect a snubber across the load. Failure to connect a snubber across the load (relay contacts) can result in generation of electromagnetic noise which could disrupt nearby electrical equipment, including your 1794 FLEX I/O chassis. Use Allen-Bradley part number 599-KA04 or 1401-NX1.



2. Connect 24V DC return to terminal 16 on the **16...33** row (B).
3. Connect +24V DC power to terminal 34 on the **34...51** row (C).
4. If daisy chaining power to the next terminal base, connect a jumper from terminal 51 (+V DC) on this base unit to terminal 34 on the next base unit.
5. If continuing DC common to the next base unit, connect a jumper from terminal 33 (common) on this base unit to terminal 16 on the next base unit.

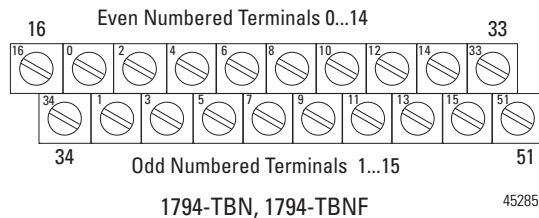

Wiring Connections for the 1794-OW8, 1794-OW8K, 1794-OW8XT

Output Channel	1794-TB2, 1794-TB3, 1794-TB3S	1794-TBN, 1794-TBNF
	Output Terminal	Output Terminal
0	A-0	B-0
	A-1	C-1
1	A-2	B-2
	A-3	C-3
2	A-4	B-4
	A-5	C-5
3	A-6	B-6
	A-7	C-7
4	A-8	B-8
	A-9	C-9
5	A-10	B-10
	A-11	C-11
6	A-12	B-12
	A-13	C-13
7	A-14	B-14
	A-15	C-15
	A-(even) = one contact of the relay A-(odd) = the other contact of the relay	B-(even) = one contact of the relay C-(odd) = the other contact of the relay
+24V DC	C-34...C-51 (1794-TB3, 1794-TB3S) C-34 and C-51 (1794-TB2)	C-34 and C- 51
-24V DC (RET)	B- 16...B-33	B-16 and B-33

Image Table Memory Map

Dec.	15	14	13	12	11	10	09	08	07	06	05	04	03	02	01	00	
Oct.	17	16	15	14	13	12	11	10	07	06	05	04	03	02	01	00	
Read Word	Not used - reserved																
Write Word	Not used - set to 0									07	06	05	04	03	02	01	00

Where: 0 = Output number (00 corresponds to output 0, 01 corresponds to output 1, and so on)
When bit = 0, output 0 is off; when bit=1, output 0 is on.

WARNING



The 1794-TBNF and 1794-TBNFK are not approved for use in Class I Division 2 applications.

Installing or Changing a Fuse in the 1794-TBNF

This terminal base unit has fuse holders for 5 x 20 mm fuses on each of the 8 even-numbered I/O terminals 0...14 (row B). To install or change a fuse:

1. Press the fuse holder down toward the terminal strip.
Press down to open

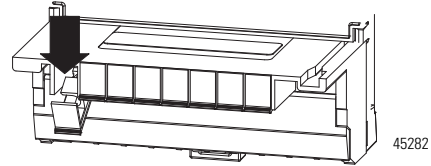

2. If replacing a fuse, remove the fuse from the fuse holder.
3. Insert a known good 5 x 20 mm fuse (Littelfuse pt. no. 239003, 3.0 A, 250V AC slow-blow) into the fuse holder.
4. Replace the fuse holder by rotating the fuse holder back to vertical until it snaps into the locked position.

General Specifications

Attribute	Value
Outputs per module	1 group of 8 Form A isolated (normally open) electromechanical relays
Module location	Mounts on 1794-TB2, 1794-TB3, 1794-TB3S, 1794-TBN and 1794-TBNF Terminal Base Units. When using 1794-TBNF terminal base unit, use 3.0 A, 250V AC slow-blow fuses (Littelfuse pt. no. 239003)
Off-State leakage current (max at 240V AC)	1.0 mA through snubber circuit
Minimum contact load	100 μ A @ 100 mV DC
Flexbus current	5V DC, 35 mA
Supply voltage	24V DC, 125 mA (1794-OW8, 1794-OW8K) 19.2...31.2V DC, 126 mA (1794-OW8XT)
Relay Contact	250V AC, 2 A, 50/60Hz, Resistive; 120/240V AC, 50/60Hz, 1800V A Make, 180V A Break; 5...30V DC, 2 A, Resistive;
Pilot Duty Rating	R150, 5...30V DC, 28V A not to exceed 1 A below 28V DC
Output signal delay	OFF to ON 10 ms max (time from valid output on signal to relay energization by module) ON to OFF 10 ms max (time from valid output off signal to relay deenergization by module)
Initial contact resistance	30 m Ω
Switching frequency	1 operation/3 s (0.3Hz at rated load) max
Bounce time	1.2 ms (mean)
Expected life of electrical contacts	100,000 operations, min @ rated loads
Thermal dissipation	18.8 BTU/hr max
Power dissipation	5.5 W
Isolation voltage	250V (continuous), Basic Insulation Type, relay to relay, relay to backplane, and relay to power 50V (continuous), Basic Insulation Type, power to backplane Type tested at 1500V AC for 60 s, relay to relay, all combinations. Type tested at 3250V DC for 60 s, relay to backplane and relay to power Type tested at 720V DC for 60 s, power to backplane.
Fusing	Fusing of outputs is recommended. Use 3.0 A, 250V AC slow-blow fuses (Littelfuse pt. no. 239003).
Indicators	8 yellow status indicators
Keyswitch position	9
Terminal screw torque	Determined by installed terminal base
Dimensions (with module installed)	94H x 94W x 69D mm (3.7H x 3.7W x 2.7D inch)
Enclosure	None (open-style)
Wiring category ⁽¹⁾	2 - on signal ports
Wire size	Determined by installed terminal base
IEC temp code	T4 (1794-OW8XT) T5 (1794-OW8, 1794-OW8K)
North American temp code	T4 (1794-OW8XT) T5 (1794-OW8, 1794-OW8K)

⁽¹⁾ Use this Conductor Category information for planning conductor routing. Refer to Industrial Automation Wiring and Grounding Guidelines, publication 1770-4.1.

Environmental Specifications

Attribute	Value
Temperature, operating	IEC 60068-2-1 (Test Ad, Operating Cold), IEC 60068-2-2 (Test Bd, Operating Dry Heat), IEC 60068-2-14 (Test Nb, Operating Thermal Shock): -20...70 °C (-4...158 °F) (1794-OW8XT) -20...55 °C (-4...131 °F) (1794-OW8, 1794-OW8K)
Temperature, non-operating	IEC 60068-2-1 (Test Ab, Unpackaged Non-operating Cold), IEC 60068-2-2 (Test Bb, Unpackaged Non-operating Dry Heat), IEC 60068-2-14 (Test Na, Unpackaged Non-operating Thermal Shock): -40...85 °C (-40...185 °F)
Temperature, surrounding air, max	55 °C (131 °F) max (1794-OW8, 1794-OW8K) 70 °C (158 °F) max (1794-OW8XT)
Relative humidity	IEC 60068-2-30 (Test Db, Unpackaged Damp Heat): 5...95% noncondensing
Vibration	IEC 60068-2-6 (Test Fc, Operating): 5 g @ 10...500 Hz
Shock, operating	IEC 60068-2-27 (Test Ea, Unpackaged Shock): 12 g
Shock, non-operating	IEC 60068-2-27 (Test Ea, Unpackaged Shock): 50 g
Emissions	CISPR 11: Group 1, Class A
ESD immunity	IEC 61000-4-2: 6 kV contact discharges 8 kV air discharges
Radiated RF immunity	IEC 61000-4-3: 10V/m with 1 kHz sine-wave 80% AM from 80...2000 MHz 10V/m with 200 Hz 50% Pulse 100% AM at 900 MHz 10V/m with 200 Hz 50% Pulse 100% AM at 1890 MHz 3V/m with 1 kHz sine-wave 80% AM from 2000...2700 MHz
EFT/B immunity	IEC 61000-4-4: ±2 kV at 5 kHz on signal ports
Surge transient immunity	IEC 61000-4-5: ±1 kV line-line(DM) and ±2 kV line-earth(CM) on signal ports
Oscillatory Surge Withstand	(1794-OW8, 1794-OW8K) IEEE C37.90.1: 2.5 kV
Conducted RF immunity	IEC 61000-4-6: 10V rms with 1 kHz sine-wave 80% AM from 150 kHz...80 MHz

Certifications (when product is marked)⁽¹⁾

Attribute	Value
c-UL-us	UL Listed Industrial Control Equipment, certified for US and Canada. See UL File E65584. UL Listed for Class I, Division 2 Group A,B,C,D Hazardous Locations, certified for U.S. and Canada. See UL File E194810.
CSA	(1794-OW8, 1794-OW8K) CSA Certified Process Control Equipment. See CSA File LR54689C. CSA Certified Process Control Equipment for Class I, Division 2 Group A,B,C,D Hazardous Locations. See CSA File LR69960C.
CE	European Union 2004/108/EC EMC Directive, compliant with: EN 61326-1; Meas./Control/Lab., Industrial Requirements EN 61000-6-2; Industrial Immunity EN 61000-6-4; Industrial Emissions EN 61131-2; Programmable Controllers (Clause 8, Zone A & B) European Union 2006/95/EC LVD, compliant with: EN 61131-2; Programmable Controllers (Clause 11)
Ex	(1794-OW8XT) European Union 94/9/EC ATEX Directive, compliant with: EN 60079-15; Potentially Explosive Atmospheres, Protection "n" EN 60079-0; General Requirements II 3 G Ex nA nC IIC T4 X (1794-OW8) European Union 94/9/EC ATEX Directive, compliant with: EN 60079-15; Potentially Explosive Atmospheres, Protection "n" EN 60079-0; General Requirements II 3 G Ex nA nC IIC T5 X when used at or below 60V AC or 75V DC (1794-OW8K) European Union 94/9/EC ATEX Directive, compliant with: EN 60079-15; Potentially Explosive Atmospheres, Protection "n" EN 60079-0; General Requirements II 3 G Ex nA nC IIC T5 X

Certifications (when product is marked)⁽¹⁾

C-Tick	Australian Radiocommunications Act, compliant with: AS/NZS CISPR 11; Industrial Emissions
Ex	(1794-OW8XT) European Union 94/9/EC ATEX Directive, compliant with: EN 60079-15; Potentially Explosive Atmospheres, Protection "n" EN 60079-0; General Requirements II 3 G Ex nA nC IIC T4 X when used at or below 60V AC or 75V DC (1794-OW8, 1794-OW8K) European Union 94/9/EC ATEX Directive, compliant with: EN 60079-15; Potentially Explosive Atmospheres, Protection "n" EN 60079-0; General Requirements II 3 G Ex nA nC IIC T5 X when used at or below 60V AC or 75V DC
TÜV	(1794-OW8, 1794-OW8K, 1794-OW8XT) TÜV Certified for Functional Safety: capable of SIL 2

⁽¹⁾ See the Product Certification link at <http://www.ab.com> for Declaration of Conformity, Certificates, and other certification details.

Rockwell Otomasyon Ticaret A.Ş., Kar Plaza İş Merkezi E Blok Kat:6 34752 İçerenköy, İstanbul, Tel: +90 (216) 5698400

www.rockwellautomation.com

Power, Control and Information Solutions Headquarters

Americas: Rockwell Automation, 1201 South Second Street, Milwaukee, WI 53204-2496 USA, Tel: (1) 414.382.2000, Fax: (1) 414.382.4444

Europe/Middle East/Africa: Rockwell Automation, Vorstlaan/Boulevard du Souverain 36, 1170 Brussels, Belgium, Tel: (32) 2 663 0600, Fax: (32) 2 663 0640

Asia Pacific: Rockwell Automation, Level 14, Core F, Cyberport 3, 100 Cyberport Road, Hong Kong, Tel: (852) 2887 4788, Fax: (852) 2508 1846

Publication 1794-IN019H-EN-P - January 2011

PN-102510

Supersedes Publication 1794-IN019G-EN-P - September 2010

Copyright © 2011 Rockwell Automation, Inc. All rights reserved.