

Aluminum with/without Cover & Gasket

Images

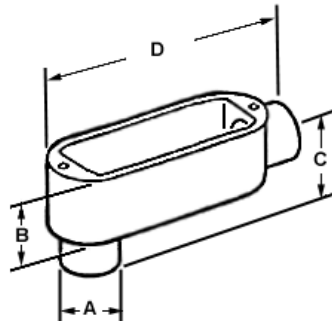

Application

Threaded bodies for rigid conduit or IMC allows access for inspection, pulling and maintenance.

Product Information

Material: Aluminum
Finish: Enamel paint

Certifications & Codes:

Federal Specification Number:	W-C-586D
NEMA Standard:	FB-1
UL File Number:	E11077
UL Standard:	UL-514A
UNSPSC:	39131708

[Download Photo Image](#)

[Download Dimensional Image](#)

Dimension A in Inches: 3-3/16
Dimension B in Inches: 3-7/16
Dimension C in Inches: 2-3/8
Dimension D in Inches: 10-3/16

Catalog ID: LB-46

UPC Number: 781747041463

Description: Rigid and IMC Conduit Body, Type LB, Aluminum, Size 2 Inch

Application: Threaded bodies for rigid conduit or IMC allows access for inspection, pulling and maintenance.

Trade Size: 2"

Std Pkg Qty: 6

Unit Qty: 1